

LEDJ

Spectra QX40 Pixel Exterior Fixture

User Manual

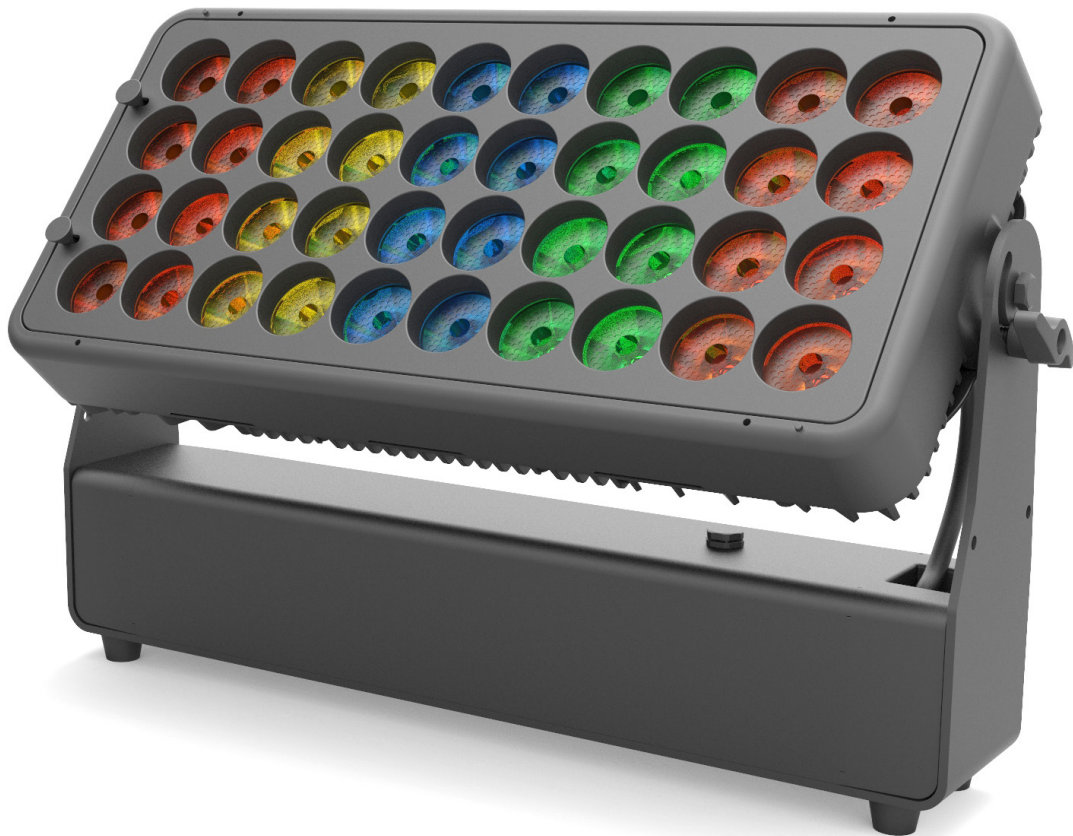

Order code: LEDJ296

WARNING

FOR YOUR OWN SAFETY, PLEASE READ THIS USER MANUAL CAREFULLY BEFORE YOUR INITIAL START-UP!

- Before your initial start-up, please make sure that there is no damage caused during transportation.
- Should there be any damage, consult your dealer and do not use the equipment.
- To maintain the equipment in good working condition and to ensure safe operation, it is necessary for the user to follow the safety instructions and warning notes written in this manual.
- Please note that damages caused by user modifications to this equipment are not subject to warranty.



IMPORTANT:

The manufacturer will not accept liability for any resulting damages caused by the non-observance of this manual or any unauthorised modification to the equipment.

- Never let the power cable come into contact with other cables. Handle the power cable and all mains voltage connections with particular caution!
- Never remove warning or informative labels from the unit.
- Do not open the equipment and do not modify the unit.
- Do not connect this equipment to a dimmer pack.
- Do not switch the equipment on and off in short intervals, as this will reduce the system's life.
- Do not expose to flammable sources, liquids or gases.
- Always disconnect the power from the mains when equipment is not in use or before cleaning! Only handle the power-cable by the plug. Never pull out the plug by pulling the power-cable.
- Make sure that the available mains supply voltage is between 100~240V AC, 50/60Hz.
- Make sure that the power cable is never crimped or damaged. Check the equipment and the power cable periodically.
- If the equipment is dropped or damaged, disconnect the mains power supply immediately and have a qualified engineer inspect the equipment before operating again.
- If your product fails to function correctly, stop use immediately. Pack the unit securely (preferably in the original packing material), and return it to your Pro Light dealer for service.
- Only use fuses of same type and rating.
- Repairs, servicing and power connection must only be carried out by a qualified technician. **THIS UNIT CONTAINS NO USER SERVICEABLE PARTS.**
- This lighting fixture is for professional use only - it is not designed for or suitable for household use. The product must be installed by a qualified technician in accordance with local territory regulations. The safety of the installation is the responsibility of the installer. The fixture presents risks of severe injury or death due to fire hazards, electric shock and falls.
- Warning! Risk Group 2 LED product according to EN 62471. Do not view the light output with optical instruments or any device that may concentrate the beam.
- **WARRANTY:** One year from date of purchase.

OPERATING DETERMINATIONS

If this equipment is operated in any other way, than those described in this manual, the product may suffer damage and the warranty becomes void. Incorrect operation may lead to danger e.g: short-circuit, burns and electric shocks etc.

Do not endanger your own safety and the safety of others!

Incorrect installation or use can cause serious damage to people and/or property.

Spectra QX40 Pixel



Equipped with 40 x 10W RGBW LEDs, the QX40 is suitable for illuminating event spaces, stages or facades, while the zone control allows lighting designers to create stunning effects. The unit utilises quad-colour LED technology to produce a wide colour spectrum from rich, primary colours through to subtle pastel hues. Designed for rental and events, the QX40 features quick release omega brackets, powerCON TRUE1 connectors for power input/output and also features both wired and wireless DMX by W-DMX Sweden. The slim profile of the fixture is ideally suited for loading into road trunks holding multiple units. A range of optional accessories including beam shaping lenses, snoots and barndoors further widen its applications.

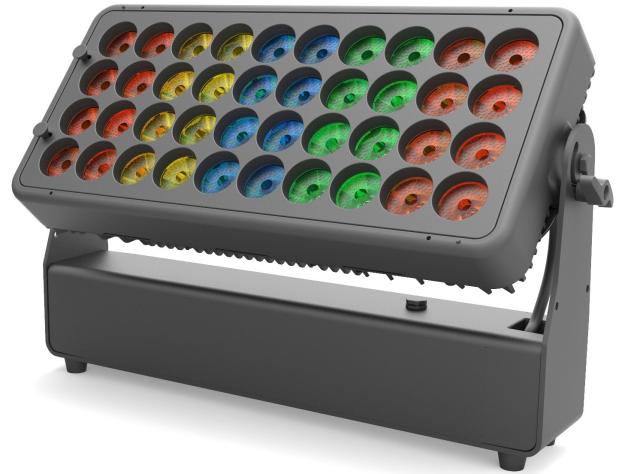

- 40 x 10W quad-colour LEDs (RGBW)
- Beam angle: 8°
- 3kHz refresh rate
- Pixel zone mapping
- Wireless DMX control by W-DMX Sweden
- DMX channels: 1/3/4/6/9/20 or 25 selectable
- Static colour, colour change and colour fade modes
- Master/slave mode when cabled
- 0 - 100% dimming and variable strobe
- 4 dimming curves: Linear, square law, inverse square law and S-curve
- Supplied with installation bracket and quick release omega clamps
- 4 button menu with OLED display
- PowerCON TRUE1 input/output
- IP rated 5-Pin XLR input/output trailing connections
- Fan cooled

Specifications	Spectra QX40 Pixel
Power consumption	410W
Power supply	100~240V, 50/60Hz
Dimensions	334 x 532 x 138mm
Weight	11.9kg
Order code	LEDJ296

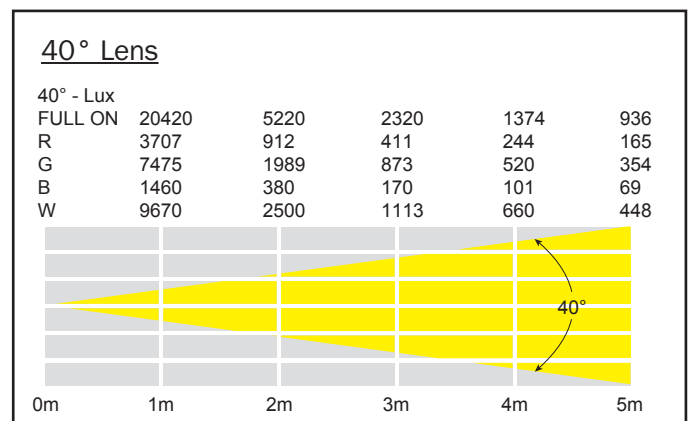
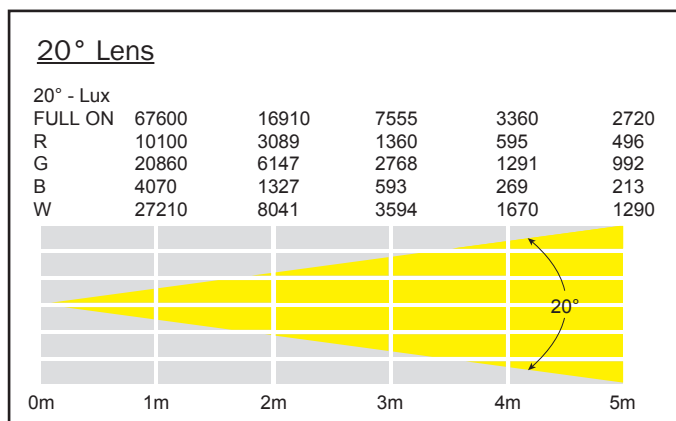
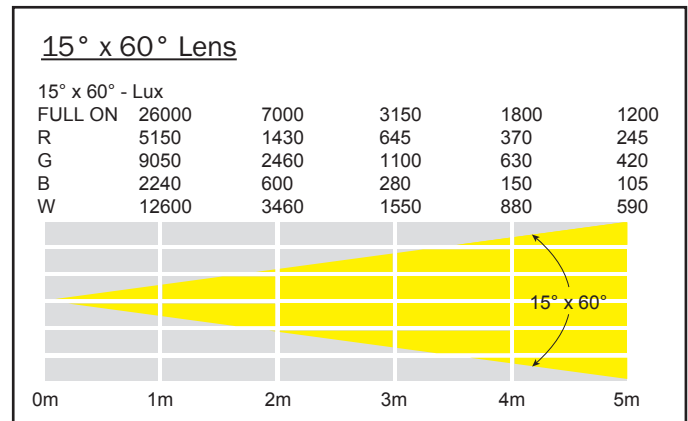
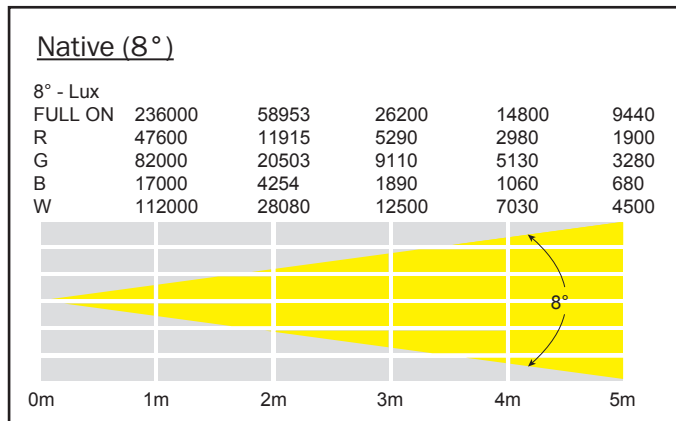

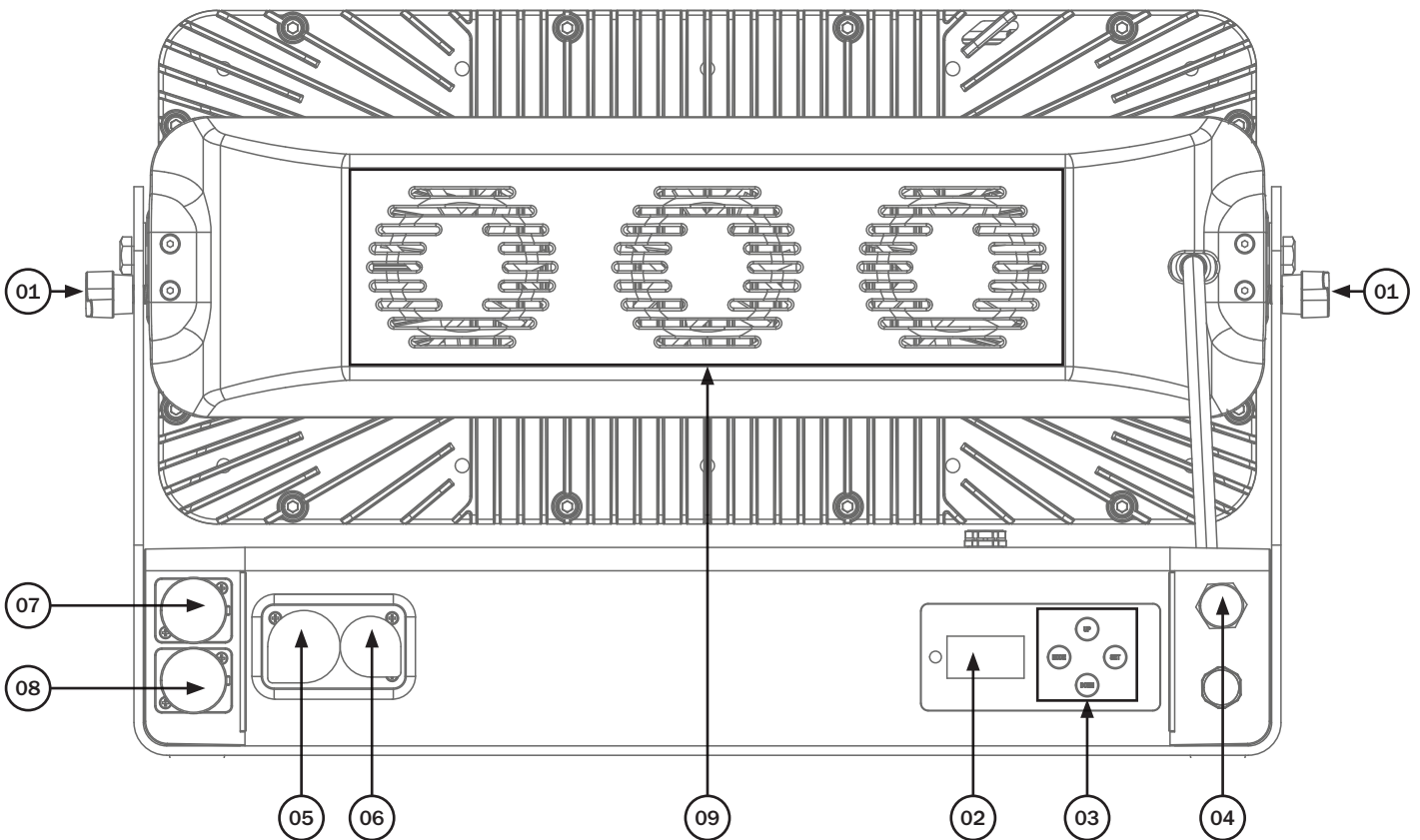
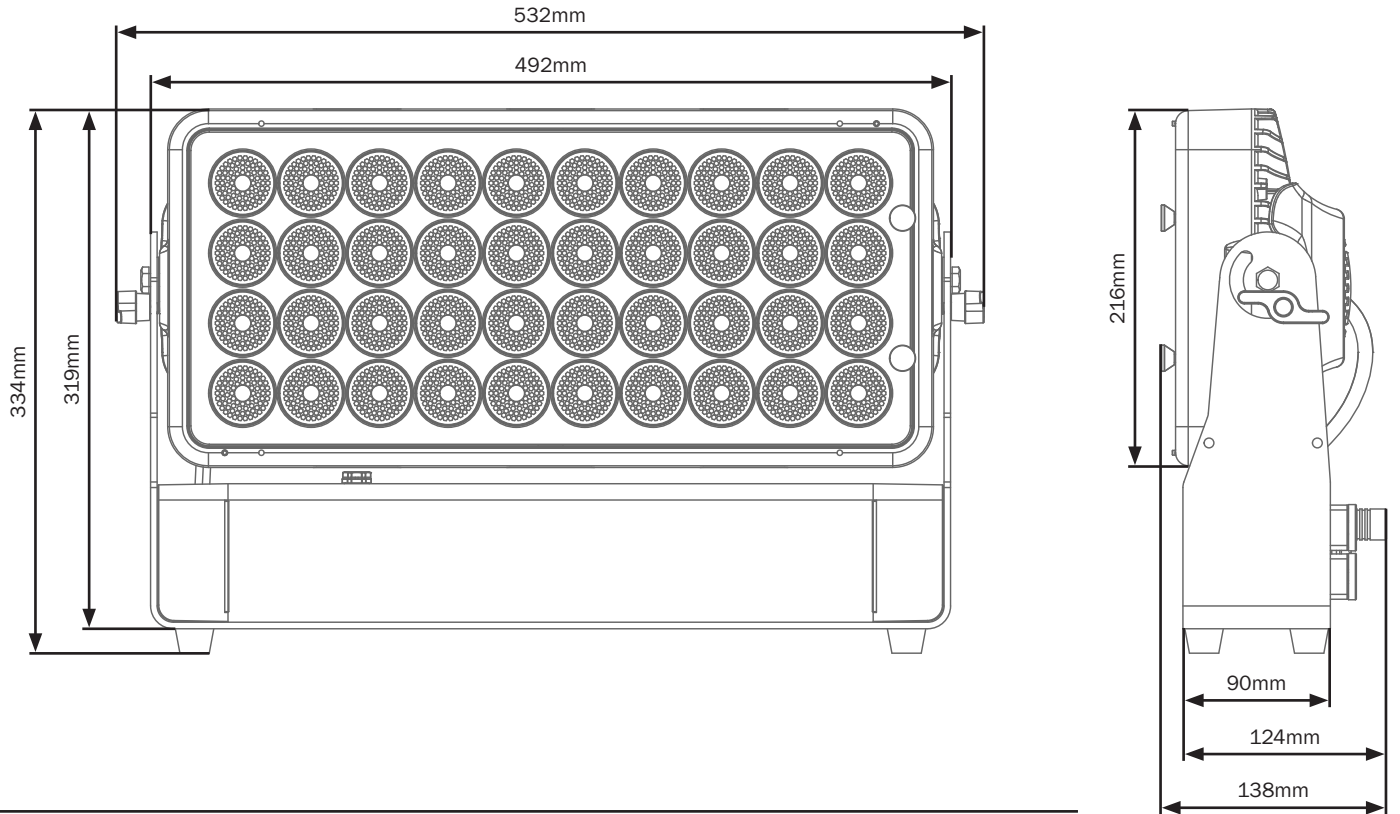

01 - Bracket tightening knobs
 02 - OLED display
 03 - Function buttons
 04 - Wireless DMX antenna

05 - PowerCON TRUE1 input
 06 - PowerCON TRUE1 output
 07 - IP rated 5-Pin XLR input
 08 - IP rated 5-Pin XLR output

09 - Fans

In the box: **1 x fixture,**
2 x omega clamps,
1 x power cable &
1 x user manual

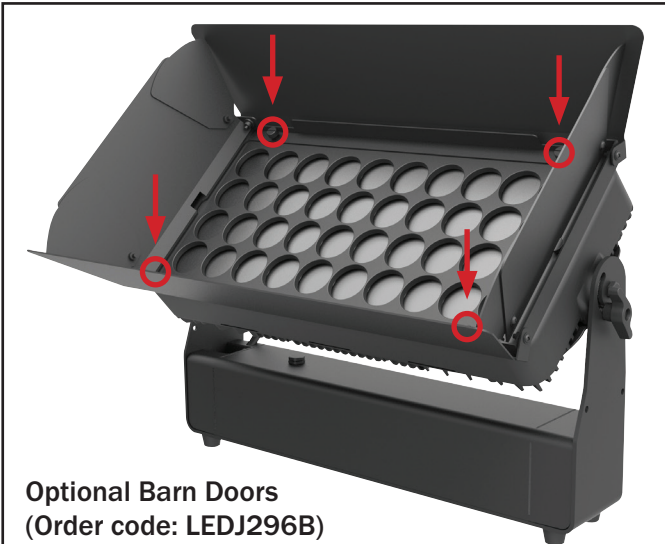

Optional Barn Doors
(Order code: LEDJ296B)

To fit the barn doors, place them over the front lens of the fixture and use the four thumbscrews located in each corner to tighten it to the fixture. The safety wire attached to the barn door can be clipped to one of the two holes in each of the side arms.



Optional Snoot
(Order code: LEDJ296S)

To fit the snoot, place it over the front lens of the fixture and use the four thumbscrews located in each corner to tighten it to the fixture. The safety wire attached to the snoot can be clipped to one of the two holes in each of the side arms.



Optional Lenses
(20° - Order code: LEDJ296L)
(40° - Order code: LEDJ296M)
(15 x 60° - Order code: LEDJ296N)

To fit the lens, slide the left side with the locating pegs into the locating slots on the left side of the fixtures frontal glass, pull back the two thumb spring clips on the right of the lens and lower the lens so it is flush with the housing. Release the spring clips which will fix the lens in place. Reverse the above steps to release the lens.

Underside mounting points:

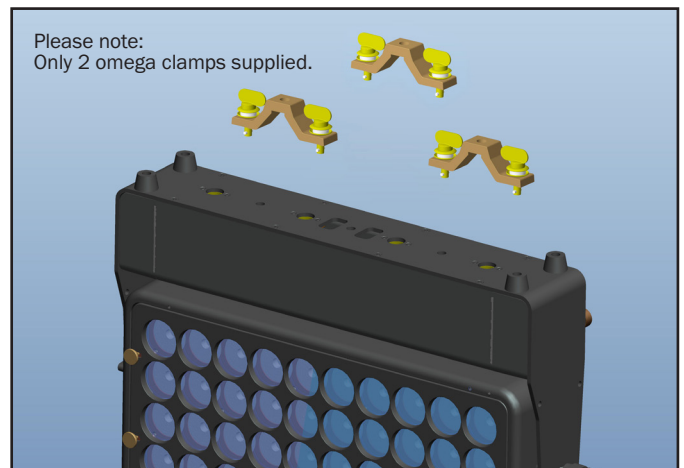

Please note:
Only 2 omega clamps supplied.

IMPORTANT! PLEASE NOTE: The OLED display for this fixture has a menu locking function where after 30 seconds of inactivity it will lock. To unlock the menu hold the “**MODE**” and “**SET**” buttons for 3 seconds.

Main Menu	Sub Menu	Options/Values		Description	
1: Auto		Yes		Auto Mode	
		No			
2: Program	1) Mode	01-15		Built-in Programs	
	2) Speed	001-100 (81)			
	3) Strobe	00-99			
3: DMX	1) Address	001-512		DMX Address Setting	
	2) Channels	01 (1 channel mode)		DMX Channel Modes	
		03 (3 channel mode)			
		04 (4 channel mode)			
		06 (6 channel mode)			
		09 (9 channel mode)			
		20 (20 channel mode)			
	3) Signal	DMX		Wired/Wireless DMX Setting	
		W-DMX			
	4) W-DMX Pair	Yes		W-DMX Pair Setting	
No					
4: Slave		Yes		Slave Mode	
		No			
5: Dimmer	1) Static Mode	Colour Preset	00-38 (01)	Static Colour Mode	
	2) All Dimmer	1) All Red	000-255		Manual Dimming Mode
		2) All Green	000-255		
		3) All Blue	000-255		
		4) All White	000-255		
	3) Part Dimmer	1) Red 1	000-255		Zone Manual Dimming Mode
		2) Green 1	000-255		
		3) Blue 1	000-255		
		4) White 1	000-255		
		5) Red 2	000-255		
		6) Green 2	000-255		
		7) Blue 2	000-255		
		8) White 2	000-255		
		9) Red 3	000-255		
10) Green 3		000-255			
11) Blue 3	000-255				

Main Menu	Sub Menu	Options/Values	Description	
5: Dimmer	3) Part Dimmer	17) White 3	000-255	Zone Manual Dimming Mode
		18) Red 4	000-255	
		19) Green 4	000-255	
		20) Blue 4	000-255	
		16) White 4	000-255	
		17) Red 5	000-255	
		19) Green 5	000-255	
		19) Blue 5	000-255	
		20) White 5	000-255	
6: Setting	1) Curves Select	1) Linear	Dimming Curve Setting	
		2) Square Law		
		3) Inv Square Law		
		S-Type		
	2) Dimmer Speed	Fast	Dimming Speed Setting	
		Smooth		
	3) Fan Speed	1) Auto	Fan Speed Setting	
		2) High		
		3) Slow		
	4) DMX Fail	1) Blackout	DMX Fail Setting	
		2) Hold		
		3) Auto		
		4) Program		
	5) Dmx Sync	On	DMX Synchronisation Setting	
		Off		
	6) Lock	On	Display Lock Setting	
		Off		
7) Factory	Yes	Reset Factory Defaults		
	No			
7: Information		Versions: Temperature: Signal: UID:	Fixture Information	

PLEASE NOTE: The DMX Synchronisation setting should be set to on when using the built-in presets via DMX to ensure the fixtures stay synchronised.

Static colour macros:

0	Blackout
1	Red
2	Flame Red
3	Deep Golden Amber
4	Millennium Gold
5	Gold Amber
6	Orange
7	Chrome Orange
8	Deep Amber
9	Spring Yellow

10	Lime Green
11	JAS Green
12	Fern Green
13	Moss Green
14	Primary Green
15	Dark Green
16	Green
17	Medium Blue/Green
18	Light Blue
19	Lighter Blue

20	Steel Blue
21	Half CT Blue
22	Full CT Blue
23	State Blue
24	Double CT Blue
25	Medium Blue
26	Just Blue
27	Deep Blue
28	Blue
29	Congo Blue

30	Surprise Pink
31	Fuchsia Pink
32	Follies Pink
33	Special Rose Pink
34	Pink
35	Moroccan Pink
36	Warm White
37	Cold White
38	White

W-DMX settings:

To enable W-DMX, press the **“MODE”** button and use the **“UP”** and **“DOWN”** buttons to select **“DMX”**.

Press the **“UP”** and **“DOWN”** button and use the **“UP”** and **“DOWN”** buttons to select **“Signal”**.

Press the **“SET”** button and use the **“UP”** and **“DOWN”** buttons to select **“W-DMX”**.

Press the **“SET”** button to confirm the setting and use the **“DOWN”** button to select **“W-DMX Pair”**.

Press the **“SET”** button and use the **“UP”** and **“DOWN”** buttons to select **“Yes”**. Press the **“SET”** button to pair the unit with your transmitter. Alternatively you can pair the fixture by holding down the **“MODE”** button until the display shows **“W-DMX Pair”**.

The green LED to the left of the display will flash indicating it is searching for a signal.

The green LED will become static once successfully paired.

To disable W-DMX, press the **“MODE”** button and use the **“UP”** and **“DOWN”** buttons to select **“DMX”**.

Press the **“UP”** and **“DOWN”** button and use the **“UP”** and **“DOWN”** buttons to select **“Signal”**.

Press the **“SET”** button and use the **“UP”** and **“DOWN”** buttons to select **“W-DMX”**.

Press the **“SET”** button to confirm the setting and use the **“DOWN”** button to select **“W-DMX Pair”**.

Press the **“SET”** button and use the **“UP”** and **“DOWN”** buttons to select **“No”**. Press the **“SET”** button to confirm the setting.

The green LED will go off to confirm W-DMX has been disabled.

To exit out of any of the above options, press the **“MENU”** button.

1 channel mode:

Channel	Value	Function
1	000-010	Blackout
	011-016	Red
	017-022	Flame Red
	023-028	Deep Golden Amber
	029-034	Millennium Gold
	035-040	Gold Amber
	041-046	Orange
	047-052	Chrome Orange
	053-058	Deep Amber
	059-064	Spring Yellow
	065-070	Lime Green
	071-076	JAS Green
	077-082	Fern Green
	083-088	Moss Green
	089-094	Primary Green
	095-100	Dark Green
	101-106	Green
	107-112	Medium Blue/Green
	113-118	Light Blue
	119-124	Lighter Blue
	125-130	Steel Blue
	131-136	Half CT Blue
	137-142	Full CT Blue
	143-148	State Blue
	149-154	Double CT Blue
	155-160	Medium Blue
	161-166	Just Blue
	167-172	Deep Blue
	173-178	Blue
	179-184	Congo Blue
	185-190	Surprise Pink
	191-196	Fuchsuia Pink
	197-202	Follies Pink
203-208	Special Rose Pink	
209-214	Pink	
215-220	Moroccan Pink	
221-226	Warm White	
227-232	Cold White	
233-255	White	

3 channel mode:

Channel	Value	Function
1	000-255	Red (0-100%)
2	000-255	Green (0-100%)
3	000-255	Blue (0-100%)

4 channel mode:

Channel	Value	Function
1	000-255	Red (0-100%)
2	000-255	Green (0-100%)
3	000-255	Blue (0-100%)
4	000-255	White (0-100%)

6 channel mode:

Channel	Value	Function
1	000-255	Master dimmer (0-100%)
2	000-255	Red (0-100%)
3	000-255	Green (0-100%)
4	000-255	Blue (0-100%)
5	000-255	White (0-100%)
6	000-010	No function
	011-255	Strobe (slow-fast)

9 channel mode:

Channel	Value	Function
1	000-255	Master dimmer (0-100%)
2	000-255	Red (0-100%)
3	000-255	Green (0-100%)
4	000-255	Blue (0-100%)
5	000-255	White (0-100%)
6	000-010	Blackout
	011-016	Red
	017-022	Flame Red
	023-028	Deep Golden Amber
	029-034	Millennium Gold
	035-040	Gold Amber
	041-046	Orange
	047-052	Chrome Orange
	053-058	Deep Amber
	059-064	Spring Yellow
	065-070	Lime Green
	071-076	JAS Green
	077-082	Fern Green
	083-088	Moss Green
	089-094	Primary Green
	095-100	Dark Green
	101-106	Green
	107-112	Medium Blue/Green
	113-118	Light Blue
	119-124	Lighter Blue
	125-130	Steel Blue
	131-136	Half CT Blue
	137-142	Full CT Blue
	143-148	State Blue
	149-154	Double CT Blue
	155-160	Medium Blue
	161-166	Just Blue
	167-172	Deep Blue
	173-178	Blue
	179-184	Congo Blue
	185-190	Surprise Pink
	191-196	Fuchsia Pink
	197-202	Follies Pink
203-208	Special Rose Pink	

9 channel mode (cont.):

Channel	Value	Function
6 (cont.)	209-214	Pink
	215-220	Moroccan Pink
	221-226	Warm White
	227-232	Cold White
	233-255	White
7	000-015	No function
	016-031	Program 1
	032-047	Program 2
	048-063	Program 3
	064-079	Program 4
	080-095	Program 5
	096-111	Program 6
	112-127	Program 7
	128-143	Program 8
	144-159	Program 9
	160-175	Program 10
	176-191	Program 11
	192-207	Program 12
	208-223	Program 13
	224-239	Program 14
240-255	Program 15	
8	000-255	Program Speed (slow-fast)
9	000-010	No function
	011-255	Strobe (slow-fast)

20 channel mode:

Channel	Value	Function
1	000-255	Red 1 (0-100%)
2	000-255	Green 1 (0-100%)
3	000-255	Blue 1 (0-100%)
4	000-255	White 1 (0-100%)
5	000-255	Red 2 (0-100%)
6	000-255	Green 2 (0-100%)
7	000-255	Blue 2 (0-100%)
8	000-255	White 2 (0-100%)
9	000-255	Red 3 (0-100%)
10	000-255	Green 3 (0-100%)
11	000-255	Blue 3 (0-100%)
12	000-255	White 3 (0-100%)
13	000-255	Red 4 (0-100%)
14	000-255	Green 4 (0-100%)
15	000-255	Blue 4 (0-100%)
16	000-255	White 4 (0-100%)
17	000-255	Red 5 (0-100%)
18	000-255	Green 5 (0-100%)
19	000-255	Blue 5 (0-100%)
20	000-255	White 5 (0-100%)

25 channel mode:

Channel	Value	Function
1	000-255	Master dimmer (0-100%)
2	000-255	Red 1 (0-100%)
3	000-255	Green 1 (0-100%)
4	000-255	Blue 1 (0-100%)
5	000-255	White 1 (0-100%)
6	000-255	Red 2 (0-100%)
7	000-255	Green 2 (0-100%)
8	000-255	Blue 2 (0-100%)
9	000-255	White 2 (0-100%)
10	000-255	Red 3 (0-100%)
11	000-255	Green 3 (0-100%)
12	000-255	Blue 3 (0-100%)
13	000-255	White 3 (0-100%)
14	000-255	Red 4 (0-100%)
15	000-255	Green 4 (0-100%)
16	000-255	Blue 4 (0-100%)
17	000-255	White 4 (0-100%)
18	000-255	Red 5 (0-100%)
19	000-255	Green 5 (0-100%)
20	000-255	Blue 5 (0-100%)
21	000-255	White 5 (0-100%)
22	000-010	Blackout
	011-016	Red
	017-022	Flame Red
	023-028	Deep Golden Amber
	029-034	Millennium Gold
	035-040	Gold Amber
	041-046	Orange
	047-052	Chrome Orange
	053-058	Deep Amber
	059-064	Spring Yellow
	065-070	Lime Green
	071-076	JAS Green
	077-082	Fern Green
	083-088	Moss Green
	089-094	Primary Green
	095-100	Dark Green
	101-106	Green
	107-112	Medium Blue/Green
	113-118	Light Blue

25 channel mode (cont.):

Channel	Value	Function
6 (cont.)	119-124	Lighter Blue
	125-130	Steel Blue
	131-136	Half CT Blue
	137-142	Full CT Blue
	143-148	State Blue
	149-154	Double CT Blue
	155-160	Medium Blue
	161-166	Just Blue
	167-172	Deep Blue
	173-178	Blue
	179-184	Congo Blue
	185-190	Surprise Pink
	191-196	Fuchsia Pink
	197-202	Follies Pink
	203-208	Special Rose Pink
	209-214	Pink
	215-220	Moroccan Pink
	221-226	Warm White
	227-232	Cold White
	233-255	White
23	000-015	No function
	016-031	Program 1
	032-047	Program 2
	048-063	Program 3
	064-079	Program 4
	080-095	Program 5
	096-111	Program 6
	112-127	Program 7
	128-143	Program 8
	144-159	Program 9
	160-175	Program 10
	176-191	Program 11
	192-207	Program 12
	208-223	Program 13
	224-239	Program 14
	240-255	Program 15
24	000-255	Program Speed (slow-fast)
25	000-010	No function
	011-255	Strobe (slow-fast)

Setting the DMX address:

The DMX mode enables the use of a universal DMX controller. Each fixture requires a “start address” from 1- 512. A fixture requiring one or more channels for control begins to read the data on the channel indicated by the start address. For example, a fixture that occupies or uses 7 channels of DMX and was addressed to start on DMX channel 100, would read data from channels: 100, 101, 102, 103, 104, 105 and 106. Choose a start address so that the channels used do not overlap. E.g. the next unit in the chain starts at 107.

DMX 512:

DMX (Digital Multiplex) is a universal protocol used as a form of communication between intelligent fixtures and controllers. A DMX controller sends DMX data instructions from the controller to the fixture. DMX data is sent as serial data that travels from fixture to fixture via the DATA “IN” and DATA “OUT” XLR terminals located on all DMX fixtures (most controllers only have a data “out” terminal).

DMX linking:

DMX is a language allowing all makes and models of different manufactures to be linked together and operate from a single controller, as long as all fixtures and the controller are DMX compliant. To ensure proper DMX data transmission, when using several DMX fixtures try to use the shortest cable path possible. The order in which fixtures are connected in a DMX line does not influence the DMX addressing. For example; a fixture assigned to a DMX address of 1 may be placed anywhere in a DMX line, at the beginning, at the end, or anywhere in the middle. When a fixture is assigned a DMX address of 1, the DMX controller knows to send DATA assigned to address 1 to that unit, no matter where it is located in the DMX chain.

DATA cable (DMX cable) requirements (for DMX operation):

This fixture can be controlled via DMX-512 protocol. The DMX address is set on the back of the unit. Your unit requires either a standard 3-pin or 5-pin XLR connector for data input/output, see images below.



Further DMX cables can be purchased from all good sound and lighting suppliers or Prolight Concepts dealers.

Please quote:	3-Pin:	CABL10 – 2m	CABL11 – 5m	CABL12 – 10m
	5-Pin:	CABL185 – 2m	CABL187 – 5m	CABL188 – 10m

Also remember that DMX cable must be daisy chained and cannot be split.

Notice:

Be sure to follow the diagrams below when making your own cables. Do not connect the cables shield conductor to the ground lug or allow the shield conductor to come in contact with the XLRs outer casing. Grounding the shield could cause a short circuit and erratic behaviour.

Pin Configuration	
3-Pin	5-Pin
	Pin 1 - Ground
	Pin 2 - Negative
	Pin 3 - Positive
-	Pin 4 - N/C
-	Pin 5 - N/C

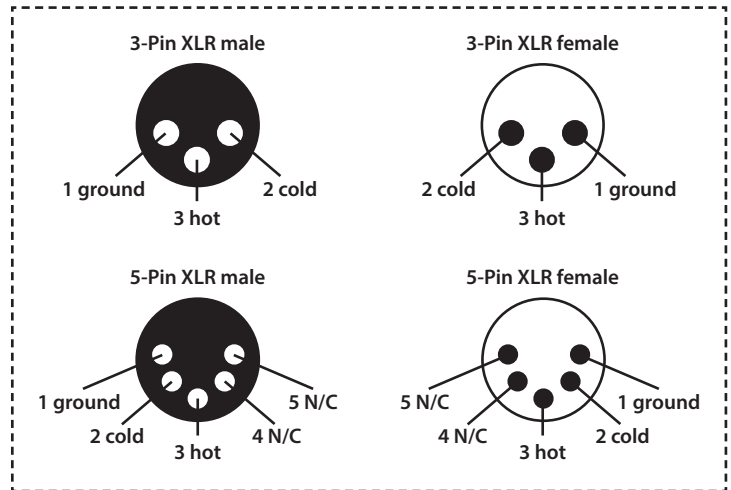
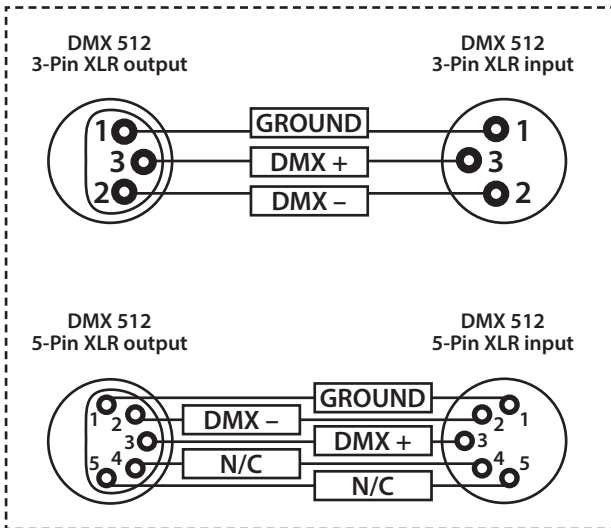

Line termination:

When longer runs of cable are used, you may need to use a terminator on the last unit to avoid erratic behaviour.

Using a cable terminator will decrease the possibilities of erratic behaviour.

(3-pin - Order ref: CABL90,
5-pin - Order ref: CABL89)

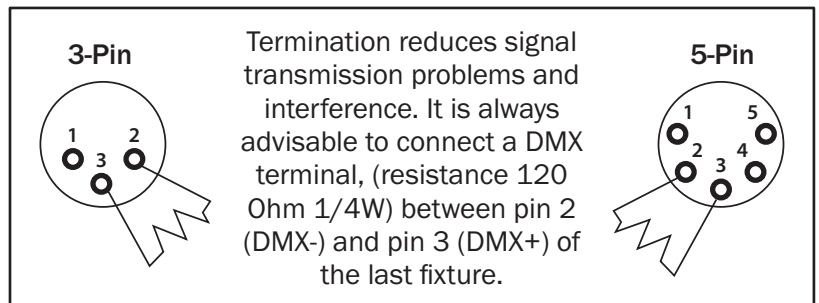

5-pin XLR DMX connectors:

Some manufactures use 5-pin XLR connectors for data transmission in place of 3-pin. 5-pin XLR fixtures may be implemented in a 3-pin XLR DMX line. When inserting standard 5-pin XLR connectors in to a 3-pin line a cable adaptor must be used. The diagram below details the correct cable conversion.

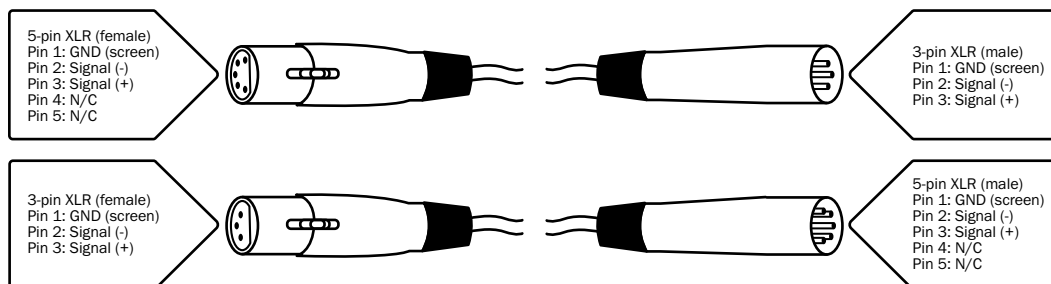

Power linking:

This fixture provides power linking via the power output on the rear allowing multiple units to be connected together. The maximum number of fixtures that can be connected is 6 fixtures @ 240V or 3 fixtures @ 120V (including the first fixture). After the maximum number of fixtures are connected a new power run will need to be started.

Please note: Caution should be used when power linking other fixtures to the Spectra QX40 Pixel as the power consumption of other fixtures will vary. Fixtures fitted with lamps often require 2/3 times more current on startup, these may require their own power source.

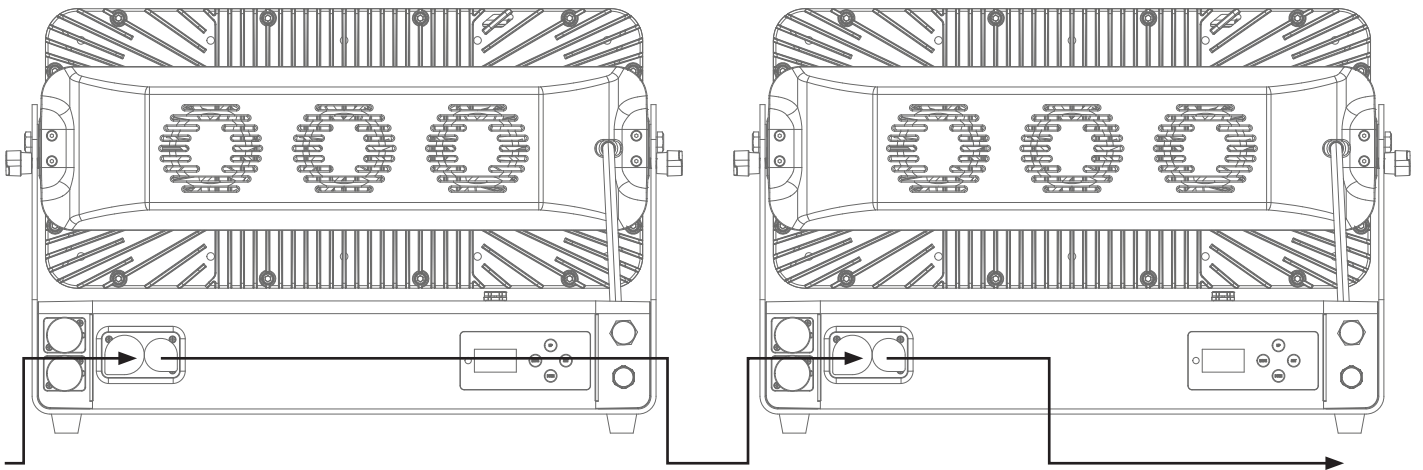



***Correct Disposal of this Product
(Waste Electrical & Electronic Equipment)***

**(Applicable in the European Union and other European countries
with separate collection systems)**

This marking shown on the product or its literature, indicates that it should not be disposed of with other household wastes at the end of its working life. To prevent possible harm to the environment or human health from uncontrolled waste disposal, please separate this from other types of wastes and recycle it responsibly to promote the sustainable reuse of material resources.

Household users should contact either the retailer where they purchased this product, or their local government office, for details of where and how they can take this item for environmentally safe recycling.

Business users should contact their supplier and check the terms and conditions of the purchase contract. This product should not be mixed with other commercial wastes for disposal.

