

Trantec S5 Wireless Microphone Series

Installation Guide



Contents

2.	Introduction, System Overview
3, 4.	Safety - Important Instructions
5 - 6.	Getting Started, Receiver Set-Up
7 - 10.	Receiver Frequency Selection
11 - 14.	Miscellaneous Settings
15, 16.	Handheld Transmitter Set-Up
17, 18.	Beltpack Transmitter Set-Up
19.	Operating Hints
20.	Troubleshooting Guide
21, 22.	Rack Mount Kit
23.	Multi-Channel Configuration with ADU
24.	Antenna Head Amplifiers
25, 26.	Mini-XLR Wiring Connections
27, 28.	Technical Specifications
29.	Warranty
30.	CE Declaration of Conformity, WEEE Statement

Introduction

The Trantec S5 series represents our commitment to our customers by providing high-quality, reliable Wireless audio links using our considerable design expertise gained over many years as a leading edge manufacturer.

We would like to thank you for purchasing this product and would like you to study this guide, especially the safety instructions before installing and using this equipment.

S5 Series System Overview

The S5 series is a professional UHF wireless microphone system with features including:

- 24 channel simultaneous operation (S5.3 12 channel)
- 10 preset banks including 1 custom user (S5.3 9 Banks)
- True “dual receiver” diversity – to minimise drop-outs
- Intuitive LCD and operating system on both receiver and transmitter
- Infra-red programming for fast system set-up
- Software transmitter function locks
- Headphone monitoring as standard
- XLR (switchable mic and line) and ¼ “jack AF outputs
- AF processing menu (S5.5 only)
- Over 1400 customer selectable channels
- Fully integrated PC software monitoring facility via USB port
- All metal construction of receiver and transmitters
- Rack kit and front mounting antenna adaptors included (S5.5 only)

Safety

Our aim is to supply you with a product that provides you with countless hours of trouble-free use. In order to achieve this goal we recommend the following:

- Keep the system away from direct sources of heat, e.g. Central heating radiators, heaters and direct sunlight.
- Do not expose the unit to an environment where it could be splashed with liquids as this may result in fire or electric shocks.
- Should the transmitters remain unused for an extended period of time we recommend that the batteries are removed to avoid any potential leakage.
- Keep the system clean by using a slightly damp cloth. Never use household cleaning agents or solvents.
- Avoid using or storing the system in damp conditions.
- Always use the AC power adaptor supplied with the receiver and always disconnect from the AC outlet when not in use. Never remove the external covers of the equipment, exposing the electronics, or modify the unit in any way.
- Do not handle the mains lead with wet hands
- Never pull the cord of the AC adaptor, always grasp the main body of the unit when connecting/disconnecting to an AC power outlet.
- Route the AC power lead in such a way that it is not likely to be stepped on or tripped over.
- Do not use if the AC power lead becomes damaged. A damaged AC lead may cause fire or give you an electric shock.
- Never touch any part of the system during a thunderstorm as this may result in severe electric shock.
- Dispose of batteries responsibly. Do not break open or incinerate, and do not place in household waste. Consult your local waste authority for advice on disposal.

Should the covers be removed or there is any other breach of the above instructions, the warranty becomes null and void, in addition to personal risk from burns and/or electric shock.

If any of the following conditions occur when using the unit, switch off and remove the AC adaptor from the AC outlet immediately and contact your nearest dealer.

- Smoke or unusual smell
- Water or foreign metallic object inside unit
- Physically damaged housings

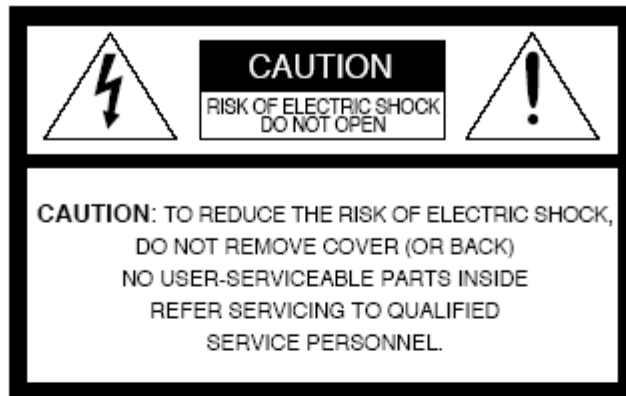

The lightning flash with arrowhead symbol, within an equilateral triangle, is intended to alert the user to the presence of uninsulated "dangerous voltage" within the product's enclosure that may be of sufficient magnitude to constitute a risk of electric shock.



The exclamation point within an equilateral triangle is intended to alert the user to the presence of important operating and maintenance (servicing) instructions in the literature accompanying the appliance.

WARNING:

TO PREVENT FIRE OR SHOCK HAZARD, DO NOT EXPOSE THIS APPLIANCE TO RAIN OR MOISTURE.

CAUTION:

TO PREVENT ELECTRIC SHOCK, DO NOT USE THIS (POLARIZED) PLUG WITH AN EXTENSION CORD, RECEPTACLE OR OTHER OUTLET UNLESS THE BLADES CAN BE FULLY INSERTED TO PREVENT BLADE EXPOSURE.

NOTE:

SINCE THIS PRODUCT IS PLUGGABLE EQUIPMENT, THE SOCKET-OUTLET MUST BE INSTALLED NEAR THE EQUIPMENT AND SHOULD BE EASILY ACCESSIBLE.

Getting Started

The S5 series is a high quality, fully featured wireless microphone system with many features, including an intuitive operating system. To enable you to get started we recommend you initially set up the system as outlined in the next few pages.

Receiver Set-Up

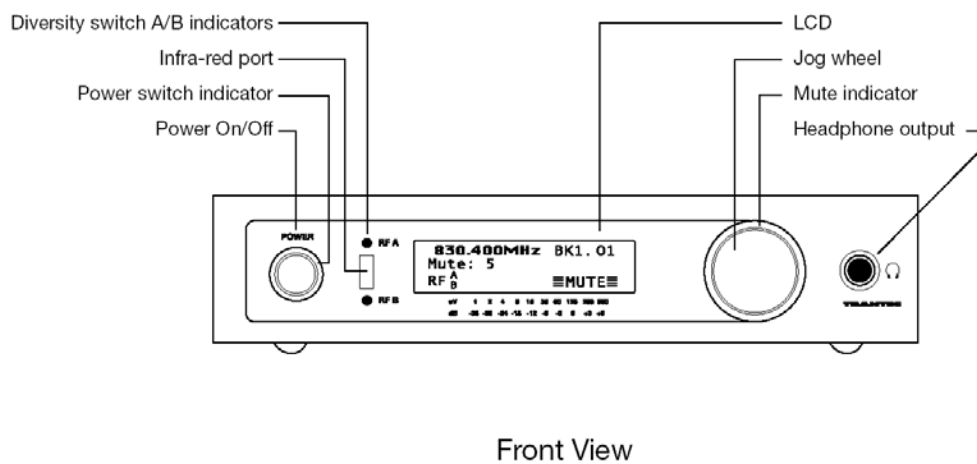
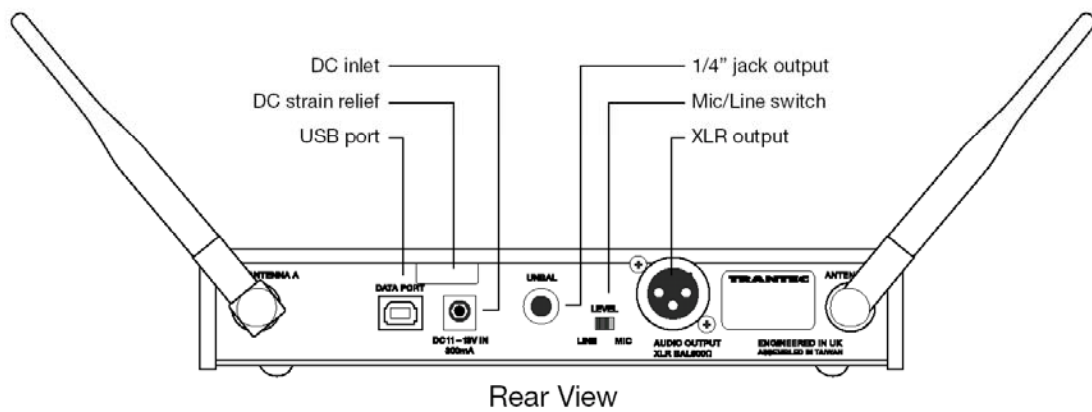



1. Attach the 2 supplied antennae to the rear panel TNC antenna connectors as shown left.

2. Connect the AC/DC adaptor into the DC inlet as marked on the rear

panel, feeding the cable through the attached strain relief. Observe that the front panel on-off switch surround is illuminated red.

3. Connect the rear panel audio output from either the ¼" jack or XLR to your mixing console or amplifier. Note: the XLR balanced output can be switched for either mic or line. The system can be also monitored from the headphone socket, using the "Jog-Wheel" to adjust the volume level.

4. Switch the On/Off switch to the "On" position. The switch surround will now be illuminated green and the receiver will default to its initial setting (BK1.01).

The system is now ready for use.

Receiver Frequency Selection

Frequency Selection Options

1. To change the selected channel in BANK1

Press and hold the “Jog-wheel” for approximately 3 seconds if the receiver is not in mute to enter the **MAIN MENU**. You will enter the **MAIN MENU** immediately if the receiver is in mute.

With **FREQ SELECT** underlined press the “Jog Wheel”.

Rotate the “Jog Wheel” till **BANK** is underlined and press.

Press to select BANK1.

Rotate the “Jog-wheel” to change the channel.

Finally, press to select the new frequency. (See the attached frequency table).

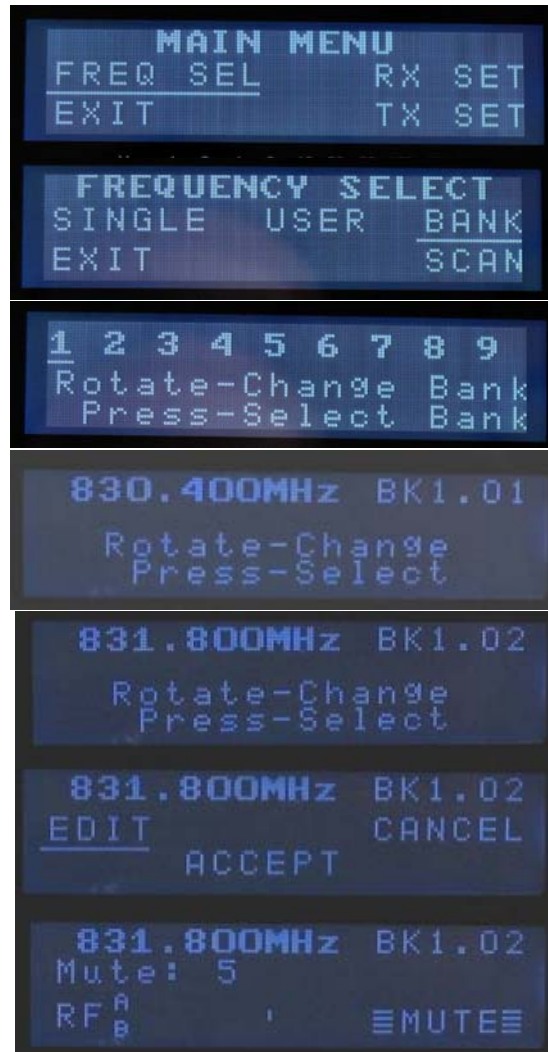

2. To change the selected Bank

Press and hold the “Jog-wheel” for approximately 3 seconds if the receiver is not in mute to enter the **MAIN MENU**. You will enter the **MAIN MENU** immediately if the receiver is in mute.

With **FREQ SELECT** underlined press the “Jog Wheel”. This will give you the next menu.

Rotate the “Jog Wheel” until **BANK** is underlined and press to give you the Bank selection screen below right.

Rotate the “Jog Wheel” to underline a new bank, then press to select.

Press to select the frequency shown or rotate to change to another frequency within this bank.

Press again with **ACCEPT** underlined to accept the new bank. (See the attached frequency table).

Go to step 4 to program the transmitter via the receiver infra-red port.

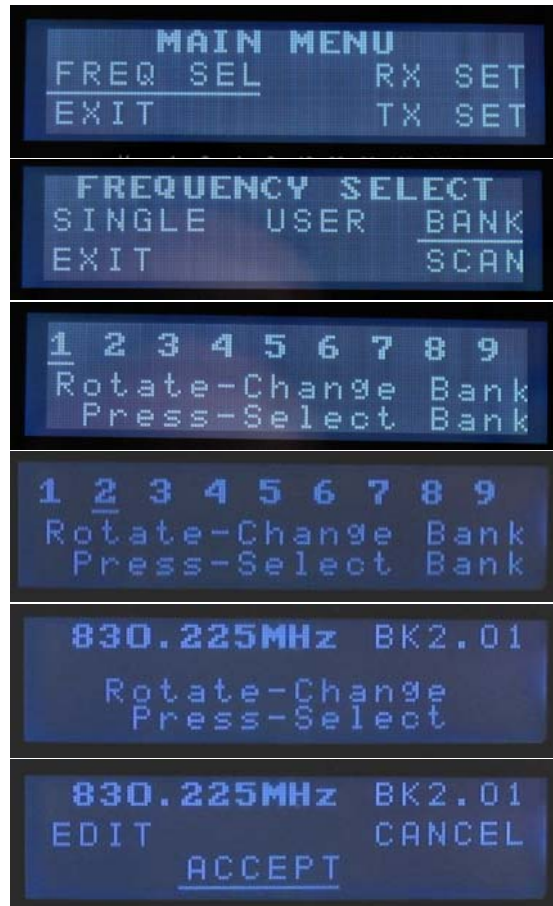

3. To change the selected channel to a Custom single frequency

This option allows the customer to select 1 of over 1400 available channels. Press and hold the “Jog-wheel” for approximately 3 seconds if the receiver is not in mute to enter the **MAIN MENU**. You will enter the **MAIN MENU** immediately if the receiver is in mute.

With **FREQ SELECT** underlined, press the “Jog-wheel”. With **SINGLE** underlined press the “Jog-wheel”. With **EDIT** underlined press the “Jog-wheel”. The first part of the frequency will be flashing. Rotate the “Jog-Wheel” to select this section of a new frequency and press to accept. The second part of the frequency will now start flashing. Change the second part of the new frequency as above. You can then change each letter of the user name in the same way. All ASCII characters are available for the user name.

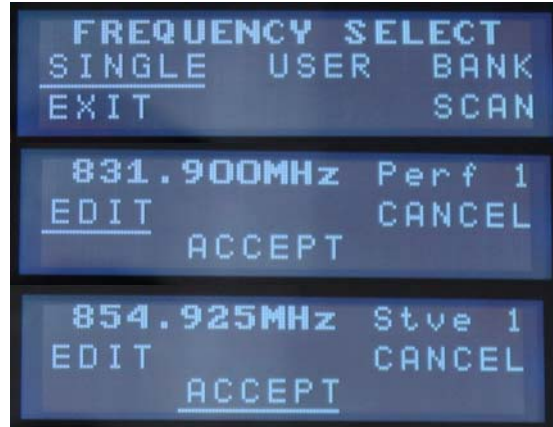

If you wish to exit this menu at any time, press and hold the “Jog-Wheel”.

Press the “Jog-Wheel” for 1 second to exit then rotate till **ACCEPT** is underlined and press to select the new custom frequency and user name. Go to the next step to program a transmitter via the receiver infra-red port.

Please note:

For S5.3 product the single user frequency will be added to the transmitter with receiver Bank1. The S5.3 does not have **USER** bank.

In the case of the S5.5 it will be added to the Custom **USER** bank. You can download **USER** banks via the Trantec software. Please refer to the software manual on this CD for more information.

Units for the Japanese market do not have **USER** or **SINGLE** options in the **FREQUENCY SELECT** menu.

4. Program a transmitter with Bank information via receiver Infra-red port

Press and hold the “Jog-wheel” for approximately 3 seconds if the receiver is not in mute to enter the **MAIN MENU**. You will enter the **MAIN MENU** immediately if the receiver is in mute.

Rotate the “Jog Wheel” till **TX SET** is underlined and press to enter **TX SETTINGS**. With **FREQUENCY** underlined, press the “Jog Wheel”. Align the transmitter and receiver infra-red windows with the transmitter no more than 15 cm from the receiver. With **SEND** underlined, press the “Jog Wheel” and wait a few



seconds. All frequencies in the bank selected will be transferred to the transmitter and its current frequency will be set to match the receiver’s current frequency. The receiver will return to its main display.

For S5.5 - If the receiver is currently in a **SINGLE** or **USER** frequency, it will transfer the **USER** bank.

For Japanese units - only fixed banks 1 to 6 are available.

For S5.3 - If the receiver is currently in a **SINGLE** frequency, it will transfer Bank1.

Miscellaneous Settings

RX Settings

Mute/Squelch Settings

The S5 series uses sophisticated internal mute functions including Pilot Tone, Noise and RSSI to prevent noise break through from external sources when the transmitter is in the “OFF” position.

The RSSI (Received signal strength) portion is user adjustable via the **RX SETTINGS MENU**. To Access this press the “Jog-Wheel” for 1 second and enter the **MAIN MENU**, or for 3 seconds if not in mute.

Rotate till **RX SET** is underlined and press. With **MUTE** underlined, press the “Jog-Wheel”. Now rotate the “Jog-Wheel” to adjust the mute setting between 1 and 10, then press. A marker shows the current mute setting in relation to the RF A and B scales. Please note: high mute settings will decrease range and low mute settings increase the interference potential. We recommend a setting of 4 to 6. The mute level changes in real time as the setting is varied.



Audio Processing (S5.5 only)

Press the “Jog-Wheel” to enter the **MAIN MENU**. Rotate till **RX SET** is underlined then press. On the **RX SETTINGS** menu, rotate till **AUDIO** is underlined and press. Options available here are **PHASE REV**, **LoCUT**, and **HiBOOST**. The default factory setting for all these options is OFF. Navigate to each option by rotating the “Jog-Wheel” and press to check the box for each option when it is underlined.



PHASE REV – reverses the audio output phase.

LoCUT – reduces the low frequency response.

HiBOOST – increases the high frequency response.

All three of the above functions change in real time as the option is selected. Rotate the “Jog-Wheel” to underline **EXIT** after making your selections, and press to return to the main screen.



Headphone Volume

Rotate the “Jog-Wheel” while the main screen is showing to go to the headphone volume adjustment. A bar graph of the volume is shown and can be altered by again turning the “Jog-Wheel”. Push to exit and return to the main screen. The unit will return to the main screen automatically if there is no user intervention for approximately 2 seconds. Any change you have made will be saved.



Scanning

The scanning feature can determine which frequencies are currently being used in the vicinity of your receiver.

From the main screen press the “Jog-Wheel” to go to **MAIN MENU**, rotate till **FREQ SEL**, is underlined and push. Then rotate till **SCAN** is underlined and push. The scanning process takes about 10 seconds and you will then be shown the Bank selection screen. If interference is found on a frequency during the scan, the bank containing that frequency is made unavailable on the receiver. You can then select any bank from those available, and any frequencies from within those banks.

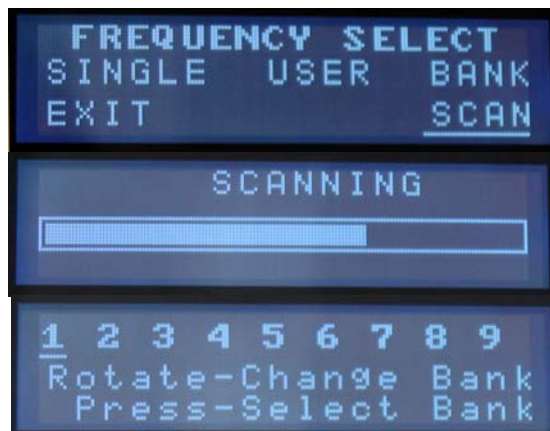

Pilot Tone

The S5 series has the ability to disable the pilot tone as a means of either identifying outside interference or allowing compatibility with non-pilot tone devices. The default factory setting is ON.

To disable Pilot Tone press the “Jog-Wheel” to go to **MAIN MENU**. Rotate till **RX SET** is underlined and push to go to the **RX SETTINGS** menu. Rotate the “Jog-Wheel” to underline **PILOT** and press to uncheck the box. Rotate the “Jog-Wheel” to exit this screen, and press to return to the main screen.

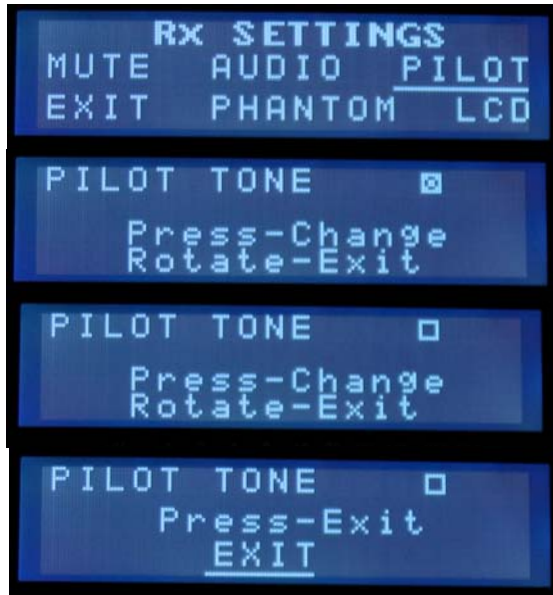

Phantom Power

DC added to the antenna inputs for powering head amplifiers. The default factory setting is OFF. Push the “Jog-Wheel” to show the **MAIN MENU**. Rotate the “Jog-Wheel” to underline **RX SETTINGS**, and push to show the next menu. Rotate to underline **PHANTOM**, and push. Press to check the **PHANTOM PWR** box. Rotate and then press to choose **EXIT** and return to the main screen.

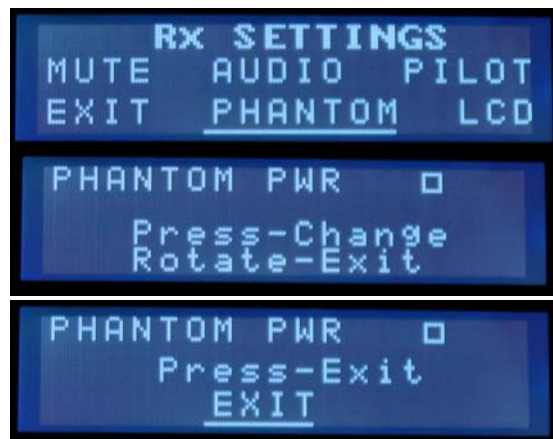

LCD Contrast

Push the “Jog-Wheel” to bring up the **MAIN MENU**. Rotate the “Jog-Wheel” to underline **RX SETTINGS**. Rotate to underline **LCD** and push, then rotate the “Jog-Wheel” to alter the **LCD CONTRAST**. Push to exit and return to the main screen. The unit will return to the main screen automatically if there is no user intervention for approximately 2 seconds. Any change you have made will be saved.



TX Settings

Lock TX Switch

To prevent unauthorised or accidental changes of frequency or gain on a transmitter, or accidentally turning a transmitter off during a performance you can lock these features from the receiver.

Press the “Jog-Wheel” to show the **MAIN MENU**. Rotate the “Jog-Wheel” to underline **TX SET** and push to select this option. Rotate the “Jog-Wheel” till **LOCK** is underlined and push to select this. Push the “Jog-Wheel” to check the box for **POWER** if required, or rotate to go to **FREQ/GAIN** and push to check this box if required.

Rotate till **EXIT** is underlined and push. You will then have the option to **SEND** the TX Locks you have selected, to a transmitter or **CANCEL**. If you are sending Locks to a transmitter you should hold it within 15cm of the receiver and with the infra-red windows of each aligned.

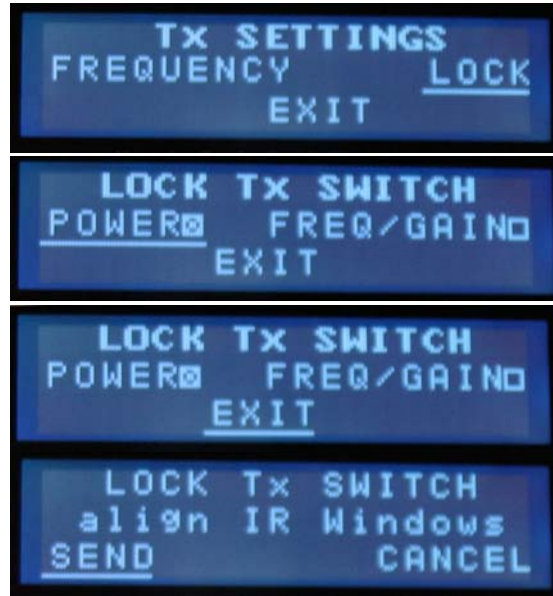

Handheld Transmitter Set-Up

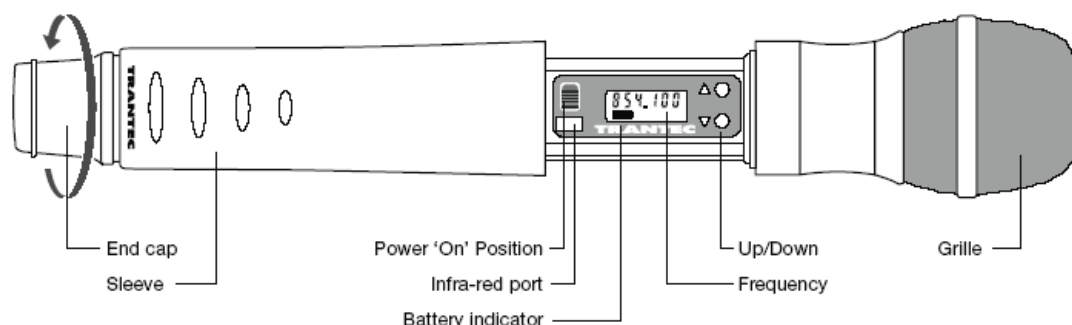

1. Opening The Microphone

Undo the handheld sleeve by unscrewing the end cap at the base anti-clockwise and then gently sliding the sleeve down to expose the LCD and Battery compartment.

2. Battery Fitting

Place an Alkaline "AA" cell into the battery compartment noting the correct polarity as shown on the label in the compartment.

3. Switch On

Slide the On/Off switch to the "On" position and observe the display is on and the Power On LED located in the end cap is illuminated.

4. Check For Received Signal

Check that the display indicates the same channel as the receiver. The receiver should now show a received signal on its RF bar graphs and after 20 seconds the transmitter battery status.

5. Gain Adjustment

Turn on the transmitter and wait for the flashing "decimal point" on the LCD to stop flashing. Press the "Up" or "Down" buttons to increase or decrease the head sensitivity. The display will show 0, 1 or 2, with 0 gain being for max SPL.



6. Frequency Adjustment

Turn on the transmitter and adjust the frequency whilst the "decimal point" is flashing (approx 6 secs) via the "Up" or "Down" buttons. When the correct frequency is selected, turn the transmitter off then on again to activate the newly selected channel.

7. Mute Switch

Incorporated in the handheld end cap is a Power On LED and Audio Mute switch. To mute the audio, flick the switch towards the LED.

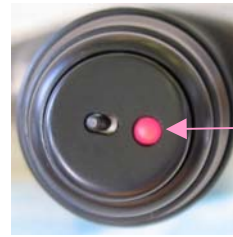

Power On
LED

Beltpack Transmitter Set-Up

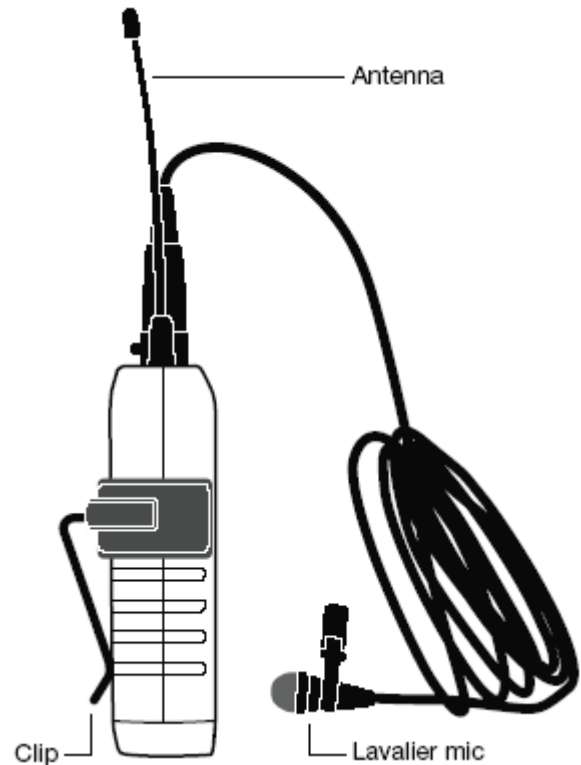
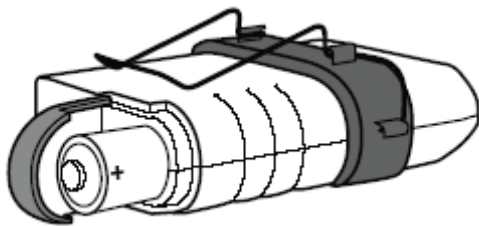
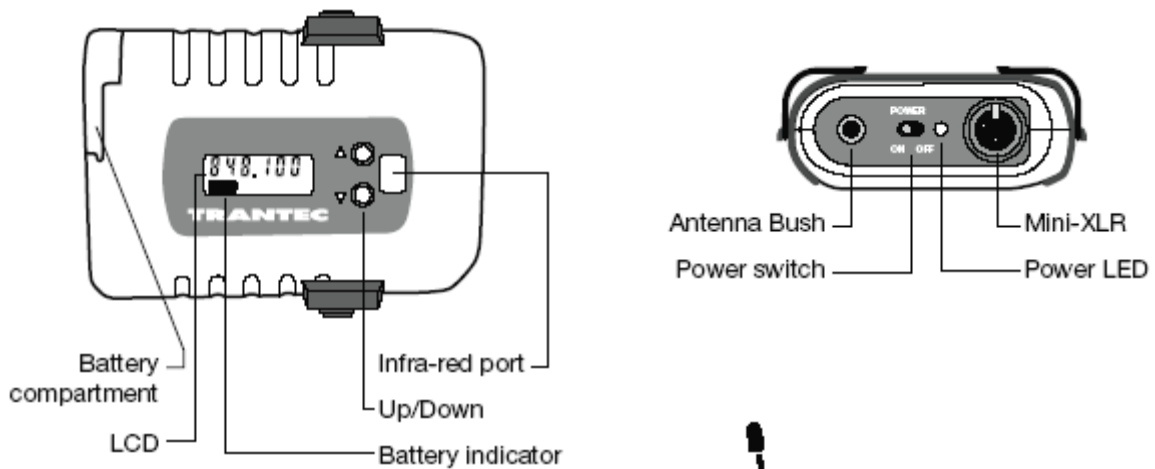

1. **Battery Fitting**

Open the battery compartment by sliding the door forward and up. Insert a battery observing the correct polarity as shown. The door is marked with a "Battery +".

2. **Antenna Fitting**

Screw the antenna into the antenna bush

3. **Microphone**

Plug a mic into the Mini-XLR socket.

4. **Switch On**

Flick the On/Off switch to the "On" position and observe the display is on and the battery LED illuminated. Check the display indicates the same channel as the receiver.

5. **Check For Received Signal**

The receiver should now show a received signal on its RF bar graphs, and after 20 seconds the transmitter battery status.

6. *Beltpack AF Gain Adjustment*

Turn the transmitter on and wait for the flashing “decimal point” on the LCD to stop flashing. Press the “Up” or “Down” buttons firmly to increase or decrease the AF gain. There are 10 steps with “0” being minimum.

7. *Frequency Adjustment*

Turn the transmitter on and adjust the frequency while the “decimal point” is flashing (approx 6 secs) via the “Up” or “Down” buttons. When the correct frequency is selected, turn the transmitter off then on again to activate the newly selected channel.

Operating Hints

To maximise operating performance Trantec recommends the following:

- Ensure good line of sight between the receiver antennae and transmitter, and avoid obstructions, e.g. concrete walls and metal structures.
- Always ensure the receiver antennae are at least 3 M (10 ft) away from the transmitters at all times.
- Always ensure the transmitters are separated by at least 50 cm.
- Never position the transmitter antenna directly against the body or the hand. This will reduce the operating range.
- Ensure the correct setting of the Mute for effective control of interference whilst the transmitter is turned off. The default is normally 5 but may need to be increased with multi-channel set-ups.
- Do not mix separate Banks in multi-channel set-ups.
- Use the **SCAN** function to check for external interference.
- Set the transmitter AF gain so the receiver VU indicates 0 db with occasional peaks to +6 dB.
- Keep the microphone/instrument lead away from the antenna on the beltpack.
- Do not mix with other brands of Wireless Microphone as Trantec cannot guarantee multi-channel compatibility.

Troubleshooting Guide

- No operation of Transmitter
Replace the current battery with a fresh one of the correct Alkaline “AA” type.
- No RF signal on receiver
Check the transmitter and receiver are “Tuned” to the same channel.
- Poor range
Check the mute level setting. For normal range we recommend a mute setting of 4-6.
- AF Signal distorted
Check the receiver XLR mic-line switch for a correct match to your Mixer/Amplifier. Reduce the gain of the transmitter if the VU meter shows over 6dB.
- AF Signal low level with high background noise
Adjust the transmitter gain so the VU bar graph shows 0dB with 6dB peaks.
- External Head amplifiers not operating
*Check for shorts in the leads and ensure the receiver **PHANTOM PWR** is switched on via the **RX SETTINGS** menu.*
- Receiver LCD contrast poor
*Enter the receiver **RX SETTINGS** menu, select **LCD** and press then rotate the “Jog-Wheel” to adjust the contrast. The receiver will automatically exit after a few seconds.*

S5 Series Rack Mount Kit

19" Rack Mounting for 2 x S5 Series Receivers



The rack mounting kit is supplied as standard with S5.5 systems, or is available as an accessory for S5.3 systems.

1. Unscrew the front 3 lid retaining screws from opposite sides of each receiver case and fit the angled rack brackets, using the supplied screws. There are 3 of these supplied with each receiver.



2. Remove the 2 plastic plugs from the top of the receiver lid and fit a metal joining strip (2 supplied per receiver) in the slots at the side of each lid of the 2 receivers. Carefully fit the M3x6 screws (1 supplied with each receiver, coloured black).

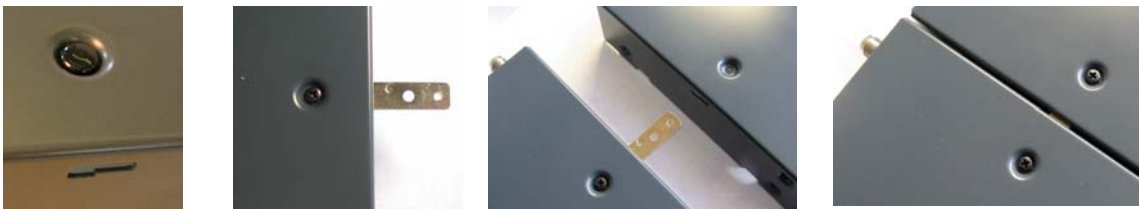

3. Fit 2 joining strips across the bottom of the receiver chassis using 4 M3x6 CSK screws (2 supplied per receiver).



19" Rack 1 x S5 Series Receiver with Front Mount Antennae

The rack mounting kit is supplied as standard with S5.5 systems, or is available as an accessory for S5.3 systems.



1. Unscrew 3 x lid retaining screws (M3x6) from the front left side of the chassis (viewed from the front) and fit the small angled rack bracket, using the supplied screws. There are 3 of these supplied with each receiver.
2. Unscrew 3 x lid retaining screws (M3x6) from the front right side of the chassis and fit the supplied long angled bracket using the screws supplied.
3. Fit the 2 supplied antenna extension cables into the front panel long bracket and tighten their TNC nuts. Screw the TNC plugs of each into the antenna sockets on the rear of the receiver. Should front mount antennae not be required, fit the 2 plastic blanking plugs supplied into the spare holes.



Multi-Channel Configuration with ADU

The S5 series is designed for simultaneous use of several systems. Ensure each system is assigned a different operating channel. Use only channels from one bank to ensure multi-channel compatibility. Try to ensure that each transmitter is separated by 0.5 M (1.5 ft) during operation.

It is recommended that for systems with 4 or more channels the Trantec Antenna Distribution Unit (ADU) is used. This allows the use of only one set of antennae to feed several receivers. Each ADU is capable of driving 4 units simultaneously with separate outputs for additional ADU units.

The diagram below shows a typical 12 channel installation. Each ADU comes complete with all necessary connecting leads for 4 channels. A 19" rack tray is available as an accessory for mounting one or two ADU units. Trantec recommends that a maximum of 12 channels is wired as illustrated below. For larger installations please consult www.trantec.co.uk

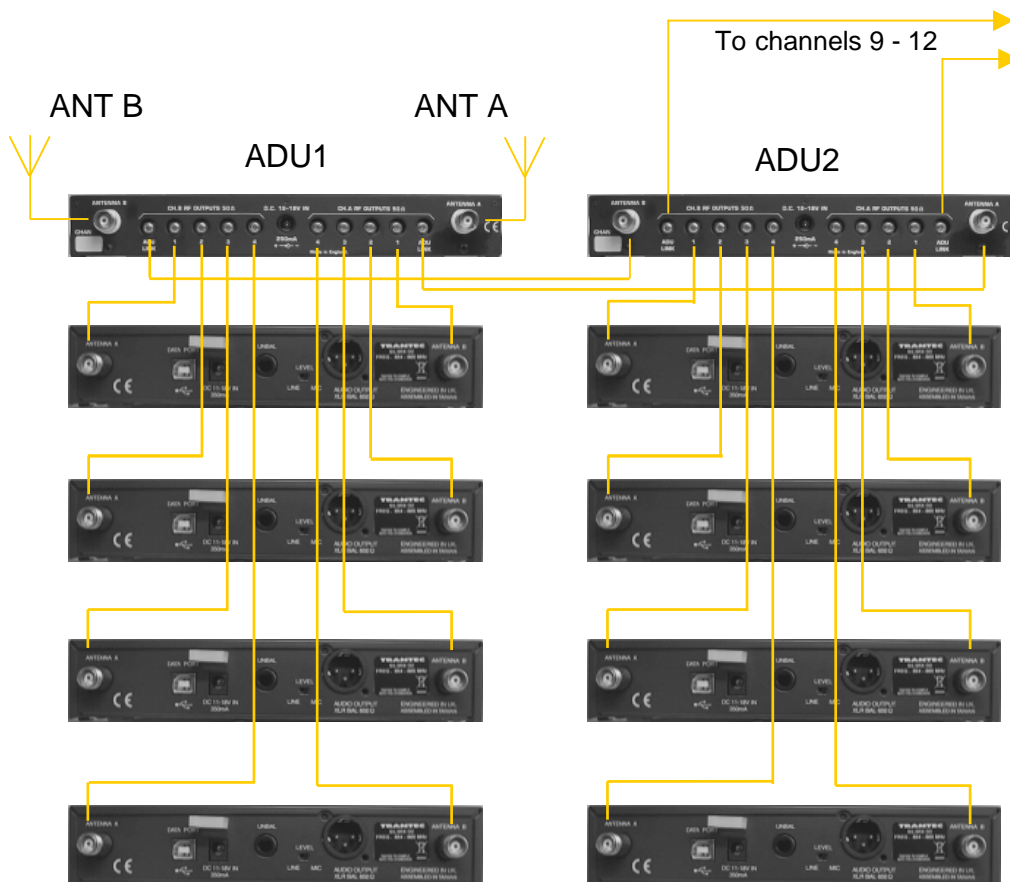

Antenna Head Amplifiers

Trantec head amplifiers are designed to reduce the effect of long RF antenna cable runs between the receivers or ADUs and remote antennae. The S/ADU and S5 Series Receiver can supply power to the head amplifier.

Please note: head amplifiers can introduce some unwanted effects, such as RF blocking and increased intermodulation, especially in multi-channel applications. To minimise such effects Trantec offers the following guidelines:

1. For cable runs of greater than 10 M and less than 20 M, when using RG58 cable, insert a head amplifier (attenuation @ 830 MHz is approx 5 dB per 10 M).
2. For cable runs of greater than 20 M and less than 40 M, when using RG213 cable, insert a head amplifier (attenuation @ 830 MHz is approx 2.5 dB per 10 M). 40 M is the recommended maximum length of cable run.
3. Ensure that transmitters are always at least 3 M from the remote receiver antennae at any time.
4. Always test the installation without the use of head amplifiers first. Only insert these if the range is found to be inadequate and below normal operating range.
5. Always ensure that the overall system RF gain does not exceed 6 dB.
6. Always insert head amplifiers at the remote antenna end of the installation.
7. The antenna head amplifier is NOT designed for outdoor installation and should not be operated in damp conditions.

Mini-XLR Wiring Connections

Beltpack Audio Mini-XLR Connections

1. Ground
2. Bias 5 V
3. AF Hi-Z
4. AF Load Resistor

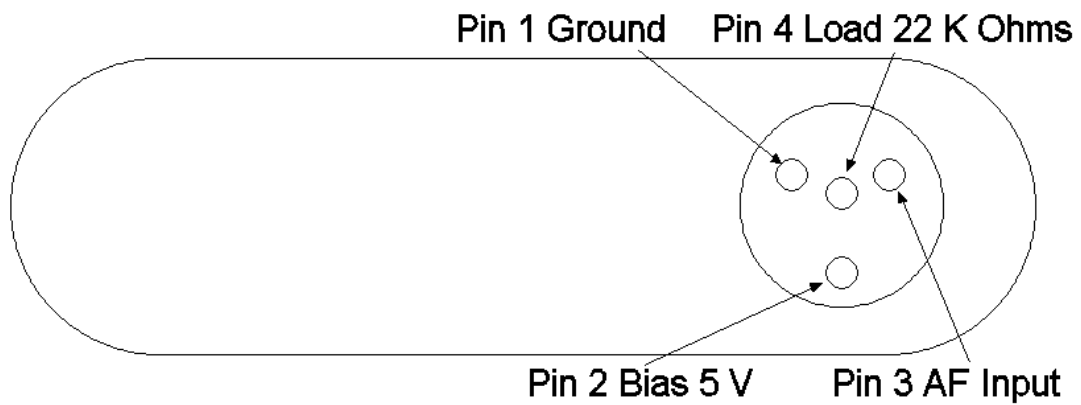

Solder connections for Mini-XLR flying socket

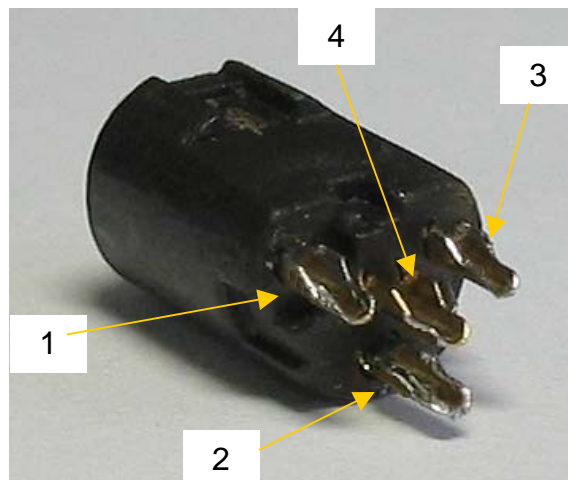

Wiring for Mini-XLR Flying Socket

2 Wire Mic

Pin 1: Ground
Pin 2: 5 V
Pin 3: AF
Pin 4: Internal AF load resistor
Link pins 3 and 4 and add a 10 K Ω bias resistor as illustrated

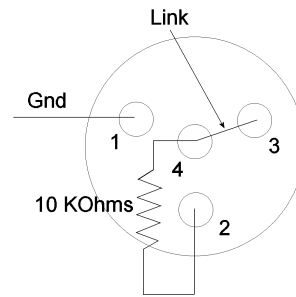

3 Wire Mic

Pin 1: Ground
Pin 2: 5 V
Pin 3: AF
Pin 4: Internal AF load resistor
Link pins 3 and 4 as illustrated

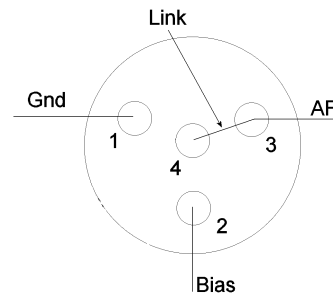

Hi Impedance Guitar/Instrument

Pin 1: Ground
Pin 2: 5 V - Not connected
Pin 3: AF Hi Z
Pin 4: Not connected
Connect screened cable to pin 1 ground and pin 3 AF Hi-Z

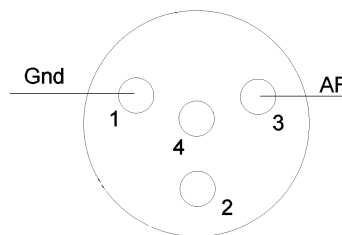

Lo Impedance Microphone (No Phantom)

Pin 1: Ground
Pin 2: 5 V - Not connected
Pin 3: AF Hi-Z
Pin 4: Internal AF load resistor
Link pins 3 and 4 and connect screened cable to pin 1 ground and pins 3 and 4 as illustrated

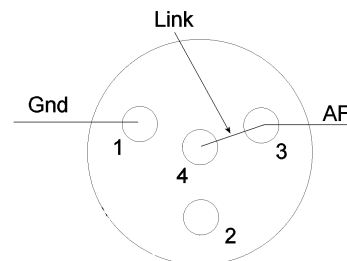

Technical Specifications

Overall System

Frequency Bands available:	A1 692-722 MHz	B1 722-752 MHz
	B2 740-752 MHz	C1 794-830 MHz
	C2 794-806 MHz	D1 863-865 MHz
	D2 854-865 MHz (S5.3 only)	D3 830-865 MHz
	E1 668-698 MHz	F1 636-666 MHz
	G1 606-638 MHz (S5.5 only)	G2 606-622 MHz (S5.3 only)

RF Switching BW: 36 MHz typ.
RF grid spacing: 25 kHz
RF Bandwidth: < 200 kHz
AF Frequency response: 60 Hz – 20 kHz
AF Distortion: < 0.8% at nom deviation 22 kHz
AF Dynamic range: >110 dBA
AF Noise reduction: Trantec proprietary
Temperature range: -10 °C to +55°C

Receiver Specification

Type: Dual Diversity featuring PLL Dual Double conversion receivers
IF Freq: 1st IF 55.875 MHz; 2nd IF 10.7 MHz
Sensitivity: < 1 uV/12 dB SINAD
1st Image: >70 dB
RSSI range: 10 steps 30 dB range
Antenna Inputs: TNC 50 Ω
AF switches: Low Cut – High Boost – Phase Reversal (S5.5 only)
AF Output level: XLR Line +15 dBm max; XLR Mic -25 dBm max; Unbalanced ¼” jack socket +9 dBm max
Antenna Phantom: 9 V @ 60 mA short-circuit protected on each RF port
Bank Specification: 10 banks x 24 channels (S5.5) (6 banks Japanese version); 9 banks x 12 channels S5.3
Infra-Red Link: Range 15 cm max
Computer Interface: Computer monitoring via rear panel USB interface
Power Consumption: 300 mA @ 12 Vdc nominal

Beltpack Transmitter Specification

Power Supply: Single Alkaline “AA” cell 1.5 V nom.
Power consumption: typically 120 mA
Operating time: typically 8 - 10 hrs min.
Controls: On-Off, AF Gain Adjust, Frequency adjust
Gain Range: +2 dBm to -20 dBm in 10 steps
Dimensions: 55 mm x 80 mm x 20 mm
Weight 110 g

Due to our continual policy of research and development we reserve the right to alter specifications without prior notice.

Lavalier Microphone Specification

Directional Characteristics: Omni-Directional
Frequency: 50 Hz – 18 kHz
Element: Back Electret-Condenser
Sensitivity: -54 dB \pm 3 dB
Impedance: 4 k Ω \pm 30% at 1kHz
Dimensions: 10.5 x 24.7 mm
Cable: 1.3 M x 2.2 mm
Connector: 4 Pin Mini-XLR
Weight: 20.5 g (excl accessories)

Dynamic Handheld Specification

Power Supply: Single Alkaline "AA" cell 1.5 V nom.
Power consumption: typically 120 mA
Operating time: typically 8 - 10 hrs min.
Capsule: Audio-Technica MU-36B
Element: Moving Coil (dynamic)
Polar Pattern: Hyper Cardioid
Frequency Response: 100 – 10000 Hz
Sensitivity: -51 dB \pm 3 dB
Controls: On-Off, AF Gain Adjust, Frequency adjust, AF Mute
Gain Range: 3 steps 6 dB
Dimensions: 32 mm x 250 mm
Weight 350 g
Grille diameter 51 mm

Condenser Handheld Specification

Power Supply: Single Alkaline "AA" cell 1.5 V nom.
Power consumption: typically 120 mA
Operating time: typically 8 - 10 hrs min.
Element: Electret condenser capsule
Polar Pattern: Cardioid
Frequency Response: 90 Hz – 20 kHz
Sensitivity: -51 dB \pm 3 dB
Controls: On-Off, AF Gain Adjust, Frequency adjust, AF Mute
Gain Range: 3 steps 6 dB
Dimensions: 32 mm x 233 mm
Weight 300 g
Grille diameter 51 mm

Due to our continual policy of research and development we reserve the right to alter specifications without prior notice.

Warranty

All Trantec products are guaranteed for a period of 12 months from the date of purchase against defects in materials and workmanship. In the event of a claim under guarantee the product should be returned in its original packing to an Authorised Service Centre or BBM Electronics, together with proof of purchase, i.e. sales purchase receipt from an authorised dealer.

BBM will repair or replace the device at its discretion. BBM offers no warranty whatsoever under the following circumstances: mechanical damage, incorrect operation, incorrect voltage, wear and tear, and defects that were known at the time of purchase. In addition, the warranty will be null and void in the event of unauthorised repair or modification, including removal of any of its covers.

E&OE. Due to our continual policy of research and development we reserve the right to alter specifications without prior notice.

Trantec Systems
BBM Electronics Group Ltd
Kestrel House
Garth Road
Morden
Surrey SM4 4LP
UK

Tel: +44 (0) 20 8330 3111
Fax: +44 (0) 20 8330 3222

E-Mail: enquiries@trantec.co.uk
Web: <http://www.trantec.co.uk>

CE Declaration of Conformity CE 0891

This equipment is in compliance with the essential requirements and other relevant provisions of Directives 1999/5/EC, 89/336/EC or 73/23/EC.

More information is available from www.trantec.co.uk

IMPORTANT NOTICE. Before using this wireless microphone system, please observe the requirements of each country with respect to frequency allocations and individual licensing requirements.

WEEE Statement



This symbol indicates that this piece of electrical/electronic equipment must be disposed of separately from normal waste at the end of its operational life. Please dispose of this product by taking it to your local recycling or collection point.