



Galactic B400

ORDERCODE 51334



Highlite International B.V.
Vestastraat 2
6468 EX Kerkrade
The Netherlands
Phone: +31 45-5667700

SHOWELECTRONICS FOR PROFESSIONALS

Congratulations!

You have bought a great, innovative product from Showtec.
The Showtec Galactic B400 brings excitement to any venue.

You can rely on Showtec, for more excellent lighting products.
We design and manufacture professional light equipment for the entertainment industry.
New products are being launched regularly. We work hard to keep you, our customer, satisfied.
For more information: iwant@showtec.info

You can get some of the best quality, best priced products on the market from Showtec.
So next time, turn to Showtec for more great lighting equipment.
Always get the best -- with Showtec !

Thank you!



Warning	2
Safety Instructions	2
Operating Determinations	5
Rigging	5
Return Procedure	6
Claims.....	6
Description of the device	7
Overview	7
Backside	8
Remote Control Operation.....	9
Installation	10
Set Up and Operation	10
Control Modes.....	11
One Galactic (Auto run visual effects)	11
One Galactic (Sound-control)	11
Multiple Galactics (Master/Slave control).....	11
Multiple Galactic (DMX Control)	12
Fixture Linking.....	12
Data Cabling.....	12
Control Panel.....	13
Control Mode	13
DMX Addressing.....	13
Menu Overview.....	14
Main Menu Options.....	14
1. DMX Mode	14
2. Slave Mode	14
3. Remote Mode	15
4. Run Test	15
5. Built-in Programs Mode / Sound Mode.....	15
6. Sensitivity Mode	15
DMX Channels	16
8 Channels.....	16
Patterns	17
Maintenance	18
Replacing a Fuse	18
Troubleshooting	18
No Light.....	18
No Response to DMX.....	18
Product Specification	20

Warning

**FOR YOUR OWN SAFETY, PLEASE READ THIS USER MANUAL CAREFULLY
BEFORE YOUR INITIAL START-UP!**

Unpacking Instructions

Immediately upon receiving this product, carefully unpack the carton and check the contents to ensure that all parts are present, and have been received in good condition. Notify the dealer immediately and retain packing material for inspection if any parts appear damaged from shipping or the carton itself shows signs of mishandling. Save the carton and all packing materials. In the event that a fixture must be returned to the factory, it is important that the fixture be returned in the original factory box and packing.

Your shipment includes:

- Galactic B400 with IEC powercable 1,75m
- Infrared Remote Control
- Remote plug and 2 keys
- User manual



**CAUTION ! EYEDAMAGES !!!
NEVER LOOK DIRECTLY INTO THE LIGHTSOURCE !!!
NEVER PROJECT A SINGLE LASER POINT !!!**

**CAUTION!
Keep this device away from rain and moisture!
Unplug mains lead before opening the housing!**

**FOR YOUR OWN SAFETY, PLEASE READ THIS USER MANUAL CAREFULLY
BEFORE YOUR INITIAL START-UP!**

Safety Instructions

Every person involved with the installation, operation and maintenance of this device have to:

- be qualified
- follow the instructions of this manual

**CAUTION! Be careful with your operations.
With a dangerous voltage you can suffer
a dangerous electric shock when touching the wires!**

Before your initial start-up, please make sure that there is no damage caused by transportation. Should there be any, consult your dealer and do not use the device.

To maintain perfect condition and to ensure a safe operation, it is absolutely necessary for the user to follow the safety instructions and warning notes written in this manual.

Please consider that damages caused by manual modifications to the device are not subject to warranty. This device contains no user-serviceable parts. Refer servicing to qualified technicians only.

IMPORTANT:

The manufacturer will not accept liability for any resulting damages caused by the non-observance of this manual or any unauthorized modification to the device.

- Never let the power-cord come into contact with other cables! Handle the power-cord and all connections with the mains with particular caution!
- Never remove warning or informative labels from the unit.
- Never use anything to cover the ground contact.
- Never leave any cables lying around.
- Do not insert objects into air vents.
- Do not connect this device to a dimmerpack.
- Do not open the device and do not modify the device.
- Never aim the laser beam at people or animals!
- Never use the device during thunderstorms, unplug the device immediately.
- Never look directly into the light source.
- Do not switch the device on and off in short intervals, as this would reduce the system's life.
- Do not shake the device. Avoid brute force when installing or operating the device.
- Only use device indoor, avoid contact with water or other liquids.
- Only operate the fixture after having checked that the housing is firmly closed and all screws are tightly fastened.
- Avoid flames and do not put close to flammable liquids or gases.
- Always check the regulations when using a class III B laser product.
- Always check and position the laser before anybody enters the room, when the laser is facing an area with people.
- Always allow free air space of at least 50 cm around the unit for ventilation.
- Always disconnect power from the mains, when device is not used or before cleaning! Only handle the power-cord by the plug. Never pull out the plug by tugging the power-cord.
- Make sure that the device is not exposed to extreme heat, moisture or dust.
- Make sure that the available voltage is not higher than stated on the rear panel.
- Make sure that the power-cord is never crimped or damaged. Check the device and the power-cord from time to time.
- If the external cable is damaged, it has to be replaced by a qualified technician.
- If the lens is obviously damaged, it has to be replaced. So that its functions are not impaired, due to cracks or deep scratches.
- If device is dropped or struck, disconnect mains power supply immediately. Have a qualified engineer inspect for safety before operating.
- If the device has been exposed to drastic temperature fluctuation (e.g. after transportation), do not switch it on immediately. The arising condensation water might damage your device. Leave the device switched off until it has reached room temperature.
- If your Showtec device fails to work properly, discontinue use immediately. Pack the unit securely (preferably in the original packing material), and return it to your Showtec dealer for service.
- For adult use only. Light effect must be installed out of the reach of children. Never leave the unit running unattended.
- For replacement use fuses of same type and rating only.
- The user is responsible for correct positioning and operating of the Galactic B400. The manufacturer will not accept liability for damages caused by the misuse or incorrect installation of this device.
- This device falls under protection class I. Therefore it is essential to connect the yellow/green conductor to earth.
- The laser will only work between 15-35°C.
- After 3 hours working, you must shut off the laser and let the laser diode cool off for 30 minutes, otherwise the laser could be damaged and the warranty becomes void.
- Repairs, servicing and electric connection must be carried out by a qualified technician.
- **WARRANTY:** Till one year after date of purchase.



CAUTION: AVOID EXPOSURE TO BEAM: Avoid direct eye contact with laser light. Never intentionally expose your eyes or others to direct laser radiation.

Compliance Statement

Your Galactic B400 Laser has been designed to comply with FDA and IEC Standards for its classification. The Galactic B400 is a Class IIIB laser product.

Laser Safety and Compliance Information

The Galactic B400 is manufactured to comply with the IEC 60825-1 and in accordance with U.S. Food and Drug Administration (FDA) Standards Listed under FDA Document 21 CFR 1040 and subsequent laser notices.

Product Classification and Manufacturing Label Identification

- Laser Classification: Class IIIB
- Cooling: TE Cooling
- Laser medium: DPSS Medium LD GeAs, wavelength 450 nm / Blue
- Output: 400mW
- Beam Diameter <5mm at aperture
- Pulse Data All pulses < 4Hz (>0.25sec)
- Divergence (each beam) <2 mrad
- Divergence (total light) <40 degrees

CAUTION: The use of corrective eye wear or optics for viewing at distances such as telescopes or binoculars within a distance of 100mm may pose an eye hazard.



This laser product is a Class IIIB laser and has an Interlocked housing.



There are no user serviceable parts inside. Tampering or removing warranty seals will void your products limited warranty.

Manufactured for:

LASER LIGHT
 AVOID DIRECT EYE EXPOSURE
 CLASS 3B LASER PRODUCT
 Maximum Output CW
 - 400mW LD DPSS
 632/473/671nm
 Classified per EN 60825-1:2011

No user serviceable parts inside.
WARRANTY VOID
 If seal is broken or has been tampered with.

Model: _____
 Serial Number: _____
 Date of Manufacture: _____

This product conforms with FDA 21 CFR 1000-1040 and subsequent Laser Notices.

CAUTION - Class 3B LASER RADIATION WHEN OPEN AVOID DIRECT EXPOSURE TO BEAM

Combo label with the Product Model Number, Serial Number, Date of Manufacturing, Laser Light Warning Label, Warranty Void Label and Interlocked Housing Label

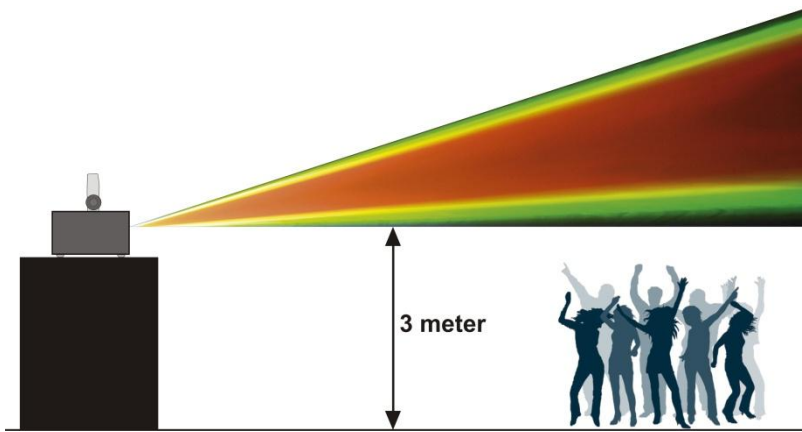

According to FDA Regulations you should operate this product as stated on the left.

Operating Determinations

- This device is not designed for permanent operation. Consistent operation breaks will ensure that the device will serve you for a long time without defects.
- The minimum distance between light-output and the illuminated surface must be more than 0.5 meter.
- The maximum ambient temperature $t_a = 45^\circ\text{C}$ must never be exceeded.
- The relative humidity must not exceed 50 % with an ambient temperature of 35°C .
- If this device is operated in any other way, than the one described in this manual, the product may suffer damages and the warranty becomes void.
- Any other operation may lead to dangers like short-circuit, burns, electric shock, crash, etc.

You endanger your own safety and the safety of others!

Rigging

Please follow the European and national guidelines concerning rigging, trussing and all other safety issues.

Do not attempt the installation yourself !

Always let the installation be carried out by an authorized dealer !

Procedure:

- If the Galactic B400 is lowered from the ceiling or high joists, professional trussing systems have to be used.
- Use a clamp to mount the Galactic B400, with the mounting-bracket, to the trussing system.
- The Galactic B400 must never be fixed swinging freely in the room.
- The installation must always be secured with a safety attachment, e.g. an appropriate safety net or safety-cable.
- When rigging, derigging or servicing the device, always make sure, that the area below the installation place is blocked and staying in the area is forbidden.

Improper installation can cause serious damage to people and property !

Connection with the mains

Connect the device to the mains with the power-plug.

Always pay attention, that the right color cable is connected to the right place.

International	EU Cable	UK Cable	US Cable	Pin
L	BROWN	RED	YELLOW/COPPER	FASE
N	BLUE	BLACK	SILVER	NUL
	YELLOW/GREEN	GREEN	GREEN	EARTH

Make sure that the device is always connected properly to the earth!



Return Procedure

Returned merchandise must be sent prepaid and in the original packing, call tags will not be issued. Package must be clearly labeled with a Return Authorization Number (RMA number). Products returned without an RMA number will be refused. Highlite will not accept the returned goods or any responsibility. Call Highlite 0031-455667723 or mail aftersales@highlite.nl and request an RMA prior to shipping the fixture. Be prepared to provide the model number, serial number and a brief description of the cause for the return. Be sure to properly pack fixture, any shipping damage resulting from inadequate packaging is the customer's responsibility. Highlite reserves the right to use its own discretion to repair or replace product(s). As a suggestion, proper UPS packing or double-boxing is always a safe method to use.

Note: If you are given an RMA number, please include the following information on a piece of paper inside the box:

- 1) Your name
- 2) Your address
- 3) Your phone number
- 4) A brief description of the symptoms

Claims

The client has the obligation to check the delivered goods immediately upon delivery for any shortcomings and/or visible defects, or perform this check after our announcement that the goods are at their disposal. Damage incurred in shipping is the responsibility of the shipper; therefore the damage must be reported to the carrier upon receipt of merchandise.

It is the customer's responsibility to notify and submit claims with the shipper in the event that a fixture is damaged due to shipping. Transportation damage has to be reported to us within one day after receipt of the delivery.

Any return shipment has to be made post-paid at all times. Return shipments must be accompanied with a letter defining the reason for return shipment. Non-prepaid return shipments will be refused, unless otherwise agreed in writing.

Complaints against us must be made known in writing or by fax within 10 working days after receipt of the invoice. After this period complaints will not be handled anymore.

Complaints will only then be considered if the client has so far complied with all parts of the agreement, regardless of the agreement of which the obligation is resulting.

Description of the device

Features

The Showtec Galactic B400 is a light effect with high output and great effects.

- When using multiple units together, you can make a great and cost effective beam-show
- Power Input: AC 100-240V, 50/60Hz
- Power Consumption: 12 Watt
- Beam Diameter <5mm at aperture
- Pulse Data All pulses < 4Hz (>0.25sec)
- Divergence (each beam) <2 mrad
- Divergence (total light) <40 degrees
- Laser Class: III B
- Laser Safety: EN/IEC 60825-1 Ed 2, 2007-03
- Laser Power: 400mW, DPSS Medium LD GeAs, wavelength 450 nm / Blue
- Scan Angle: +/-30°
- Scan Speed: Stepping motor
- Control Modes: Auto, Sound, Master/Slave, DMX
- 3-pin DMX In and 3-pin DMX Out
- Clear LCD display for all settings
- Compact strong metal housing
- Music-controlled via built-in microphone
- 8 DMX Channels
- Safety Features: Key switch, Interlock, Safety eye
- Fuse 1 A / 250V
- Dimensions: 145 x 160 x 80mm (excl. bracket)
- Weight: 1.28 Kg

- Accessories included: 2 Keys, Interlock test connector, Infrared Remote control

Overview



Fig. 1

Backside



Fig. 2

- 1) Mountingbracket with adjustment screw
- 2) 3-pin DMX Out
- 3) ON/OFF
- 4) Fuse 1A/250V
- 5) IEC Powerconnector
- 6) 3-pin DMX In
- 7) Earth connection
- 8) Remote Control
- 9) Lock On/Off
- 10) Safety Eye
- 11) LCD Display + Menu Buttons
- 12) Built-in Microphone

Remote Control Operation

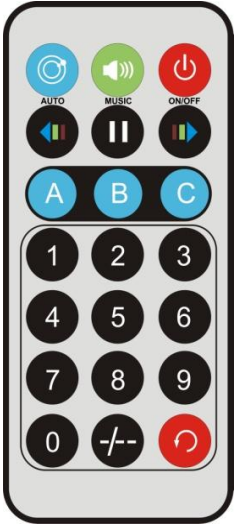

ON/OFF: In **REM** mode, use this button to turn the laser ON/OFF. In every mode, excepted SLA mode, press 2 seconds to activate REM mode.



AUTO: Automatic running show



SOUND activated show. The blue music LED indicator is flashing when sound signal is detected



B **1** - **9**

During a sound-controlled Show, press **MUSIC+B+1~9** to set the sensitivity. **9** is the most sensitive.



COLOR CHANGE: Cycle through the pre-programmed colors



PATTERN CHANGE: To show and change 48 patterns



FIXED PATTERN: Choose your favorite PATTERN from 1 to 48



Repeat



Pause

Attention: Any control or setting with the remote control will be saved, until the system is rebooted. The system is always in AUTO show after rebooting.

Installation

Remove all packing materials from the Galactic B400. Check that all foam and plastic padding is removed. Connect all cables.



Always disconnect from electric mains power supply before cleaning or servicing.
Damages caused by non-observance are not subject to warranty.

Set Up and Operation

Before plugging the unit in, always make sure that the power supply matches the product specification voltage. Do not attempt to operate a 120V specification product on 230V power, or vice versa. Connect the device to the main power supply. The device can be music-controlled by its built-in microphone.

The Interlock plug/remote plug and safety keys are included in the box.

The interlock is the "included-in-the-box" successor for the optional remote interlock (51316)

 They should be kept with the Galactic B400 laser !!! 



The following safety precautions should be followed:

- The interlock plug should be placed on the backside (8) of your Galactic B400 laser.
- The keys should be put into the lock (9) of your Galactic B400 laser.

Warning

If the plug is not connected, your laser will not function.
If the key is not set to ON, your laser will not function.



Exclusion of liability

Be aware that in some countries, there are additional regulations, regarding the use of laser devices. Therefore, we strongly advise you to check your national laws with the authorities: We don't take any responsibility for eventual discrepancies, changes or adaptations regarding lawful use of laser devices.

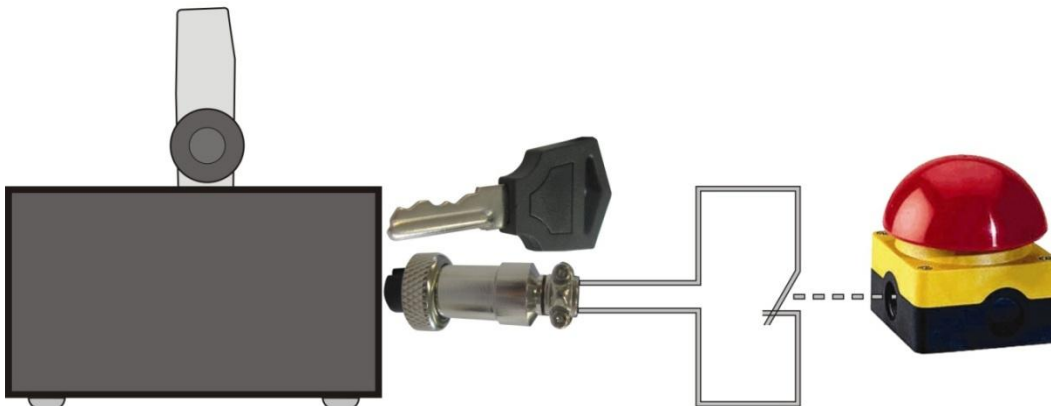

Control Modes

There are 4 modes:

- Auto run (visual effects)
- Sound-controlled
- Master/Slave
- DMX512

One Galactic B400 (Auto run visual effects)

1. Fasten the effect light onto firm trussing. Leave at least 0,5 meter on all sides for air circulation.
2. When the Galactic B400 is not connected by a DMX-cable, it functions as a stand-alone device. Please see page 15 for more information about the Auto run visual effects.

One Galactic B400 (Sound-control)

1. Fasten the effect light onto firm trussing. Leave at least 1 meter on all sides for air circulation.
2. Turn on the music. If the device is set to sound, then the Galactic B400 will react to the beat of the music. Please see page 15 for more information about the sound-control options.

Multiple Galactics (Master/Slave control)

1. Fasten the effect light onto firm trussing. Leave at least 1 meter on all sides for air circulation.
2. Always use a safety cable (ordercode 70140 / 70141).
3. Use a 3-p XLR cable to connect the Galactic B400 lasers.

The pins:



1. Earth
2. Signal -
3. Signal +

4. Link the units as shown in (Fig. 3), Connect a DMX signal cable from the first unit's DMX "out" socket to the second unit's "in" socket. Repeat this process to link the second, third, and fourth units. You can use the same functions on the master device as described on page 15 (Autorun or Music control). This means on the master device you can set your desired operation Mode and all slave devices will react the same as the master device.

Multiple Galactics (Master/Slave control)

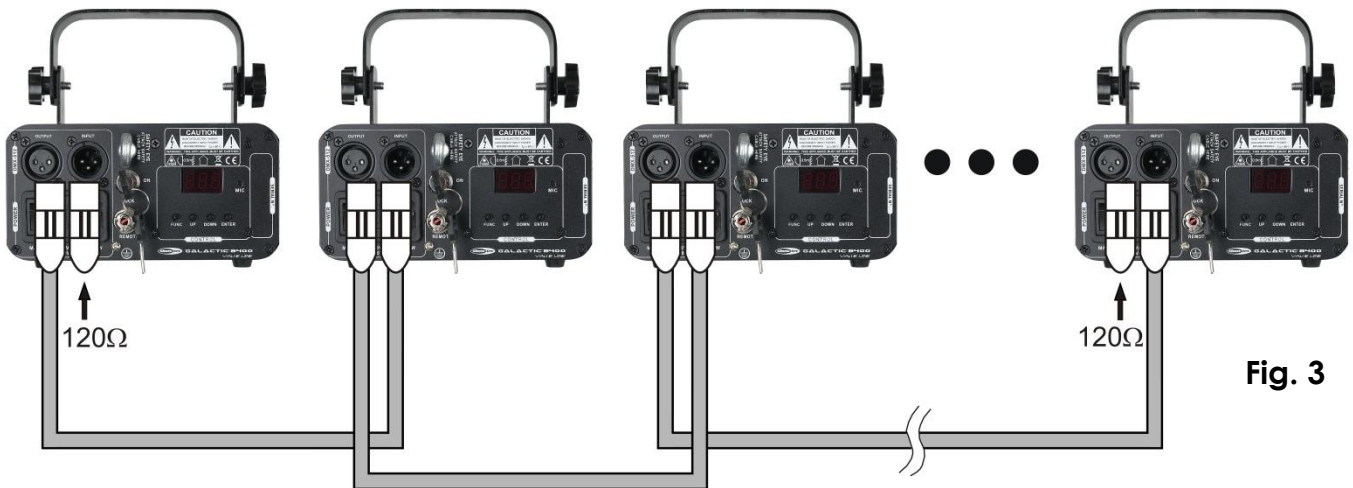

Multiple Galactic B400 (DMX Control)

1. Fasten the effect light onto firm trussing. Leave at least 1 meter on all sides for air circulation.
2. Always use a safety cable (ordercode 70140 / 70141).
3. Use a 3-p XLR cable to connect the Galactic B400 lasers.
4. Link the units as shown in (figure 4), Connect a DMX signal cable from the first unit's DMX "out" socket to the second unit's "in" socket. Repeat this process to link the second, third, and fourth units.
5. Supply electric power: Plug the end of the mains power cord into proper electric power supply sockets. Do so for all units and the controller.

Multiple Galactics Set Up

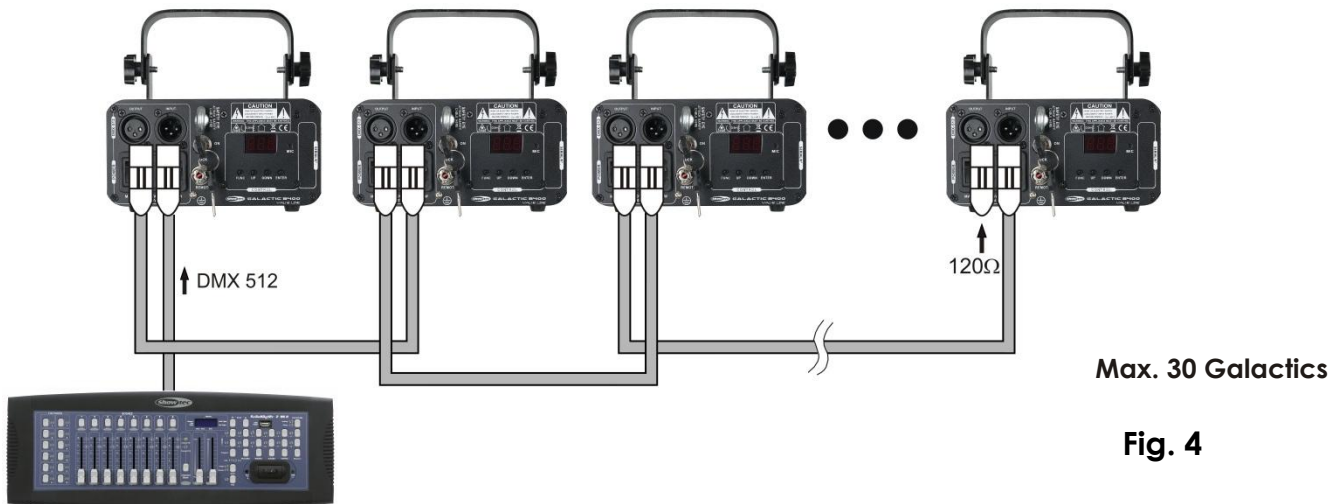

Note : Link all DMX cables and set dip switches before connecting electric power

6. Do not supply power before the whole system is set up and connected properly. Design your show according to your DMX controller functions. See page 14 for more about DMX programming.

Fixture Linking

You will need a serial data link to run light shows of one or more fixtures using a DMX-512 controller or to run synchronized shows on two or more fixtures set to a master/slave operating mode. The combined number of channels required by all the fixtures on a serial data link determines the number of fixtures the data link can support.

Important: Fixtures on a serial data link must be daisy chained in one single line. To comply with the EIA-485 standard no more than 30 devices should be connected on one data link. Connecting more than 30 fixtures on one serial data link without the use of a DMX optically isolated splitter may result in deterioration of the digital DMX signal.



Maximum recommended DMX data link distance: 100 meters
Maximum recommended number of Galactics on a DMX data link: 30 fixtures

Data Cabling

To link fixtures together you must obtain data cables. You can purchase DAP Audio certified DMX cables directly from a dealer/distributor or construct your own cable. If you choose to create your own cable please use data-grade cables that can carry a high quality signal and are less prone to electromagnetic interference.

DAP Audio Certified DMX Data Cables

- DAP Audio Basic microphone cable for allround use. bal. XLR/M 3 p. > XLR/F 3 p.
Ordercode FL01150 (1,5m.), FL013 (3m.), FL016 (6m.), FL0110 (10m.), FL0115 (15m.), FL0120 (20m.).
- DAP Audio cable for the demanding user with exceptional audio-qualities and connector made by Neutrik®. **Ordercode** FL71150 (1,5m.), FL713 (3m.), FL716 (6m.), FL7110 (10m.).

Control Panel

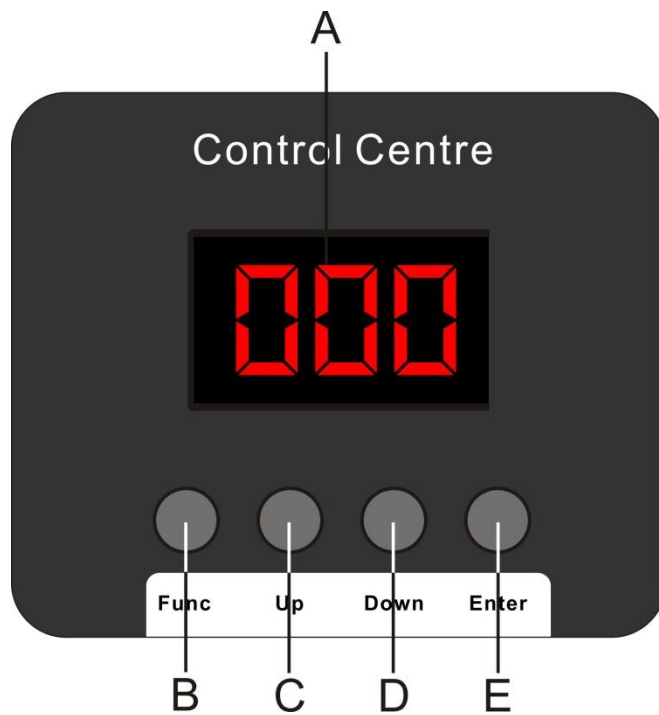

Fig. 5

A. LED Display
B. Func Button
C. Up Button

D. Down Button
E. Enter Button

Control Mode

The fixtures are individually addressed on a data-link and connected to the controller. The fixtures respond to the DMX signal from the controller.

DMX Addressing

The control panel on the front side of the base allows you to assign the DMX fixture address, which is the first channel from which the Galactic B400 will respond to the controller.

Please note when you use the controller, the unit has max. **8** channels.

When using multiple Galactic's, make sure you set the DMX addresses right.

Therefore, the DMX address of the first Galactic B400 should be **1(001)**; the DMX address of the second Galactic B400 should be **1+8=9**; the DMX address of the third Galactic B400 should be **9+8=17**, etc.

Please, be sure that you don't have any overlapping channels in order to control each Galactic B400 correctly. If two or more Galactic's are addressed similarly, they will work similarly.

Controlling:

After having addressed all Galactic's, you may now start operating these via your lighting controller.

Note: After switching on, the Galactic B400 will automatically detect whether DMX 512 data is received or not.

The problem may be:

- The XLR cable from the controller is not connected with the input of the Galactic B400.
- The controller is switched off or defective, the cable or connector is defective, or the signal wires are swapped in the input connector.

Note: It's necessary to insert a XLR termination plug (with 120 Ohm) in the last fixture in order to ensure proper transmission on the DMX data link.

Menu Overview

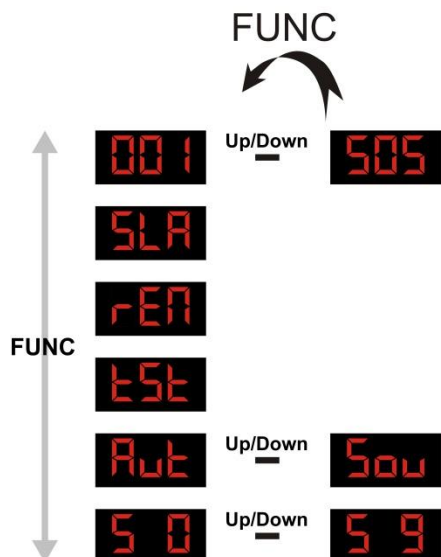



The Galactic B400 will only show its version number at start-up !

U12

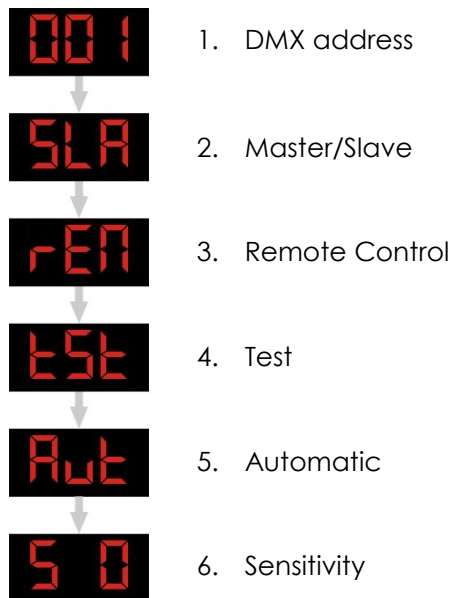
Main Menu Options



 You can only change a certain setting when the display is blinking. 
 If you can't change a certain value, please press the **Function**-button once and then change the value.

1. DMX Mode

With this menu you can set the DMX address.

- 1) Press the **FUNC** button, until the display shows **001** .
- 2) You can choose 512 different DMX addresses.
 Use the Up / Down buttons to select the required address from **001** Up/Down **505** .
- 3) Use the **ENTER** button to store your setting.

2. Slave Mode

With this menu you are able to set the device as a slave device.

- 1) Press the **FUNC** button, until the display shows **SLA** .
- 2) Use the **ENTER** button to store your setting.

3. Remote Mode

With this menu you are able to activate the remote control modus.

- 1) Press the **FUNC** button, until the display shows **REM** .
- 2) Use the **ENTER** button to store your setting.
- 3) In any standalone mode (excepted REM and SLA), press ON/OFF for 2 seconds to activate the remote function.
- 4) Please see remote control menu for more info.

4. Run Test

- 1) Press the **FUNC** button, until the display shows **EST** .
- 2) When you press **ENTER**, the device will start an internal test.

5. Built-in Programs Mode / Sound Mode

- 1) Press the **FUNC** button, until the display shows **Aut** . This is the Auto Mode.
- 2) If you want the Sound Mode, use the Up / Down buttons to select **Sou** .
- 3) Use the **ENTER** button to store your setting.

6. Sensitivity Mode

With this menu you can set the Audio Sensitivity.

- 1) Press the **FUNC** button, until the display shows **50** .
- 2) You can choose 10 different Audio Sensitivity levels.
Use the Up / Down buttons to select the required address from **50** ^{Up/Down} **59** .
50 is no audio activation.
51 ^{Up/Down} **59** is audio sensitivity, from low to highly sensitive.
- 3) Use the **ENTER** button to store your setting.

DMX Channels

8 Channels

Channel 1 – Control Modes

0-63	Laser Black Out
64-127	Auto Program
128-191	Sound-controlled
192-255	DMX Mode

Channel 2 – Patterns (when CH1 is set between 192-255)

0-255	32 patterns
-------	-------------

Channel 3 – Zoom

0-127	Zoom from 100% – 5%
128-169	Zoom In from 100% – 5% (slow to fast)
170-209	Zoom Out from 5% - 100% (slow to fast)
210-255	Zoom In and Out from slow to fast



Channel 4 – Y-axis Rolling

0-127	0-359 degree fixed Y Axis rolling
128-191	Counterclockwise rolling from slow to fast
192-255	Clockwise rolling from slow to fast



Channel 5 – X-axis Rolling

0-127	0-359 degree fixed X Axis rolling
128-191	Counterclockwise rolling from slow to fast
192-255	Clockwise rolling from slow to fast



Channel 6 – Z-axis Rolling

0-127	0-359 degree fixed X Axis rolling
128-191	Counterclockwise rotation from slow to fast
192-255	Clockwise rotation from slow to fast



Channel 7 – X-axis Moving

0-127	128 different fixed positions on X Axis
128-191	Clockwise moving from slow to fast
192-255	Counterclockwise moving from slow to fast



Channel 8 – Y-axis Moving

0-127	128 different fixed positions Y Axis
128-191	Clockwise moving from slow to fast
192-255	Counterclockwise moving from slow to fast



Patterns

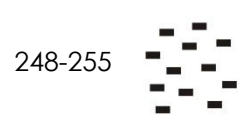
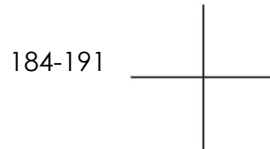
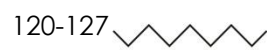
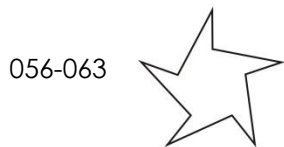
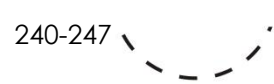
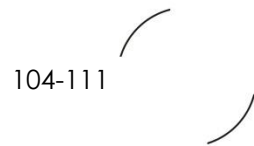
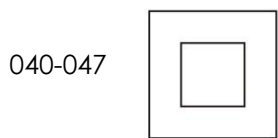
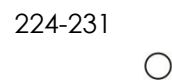
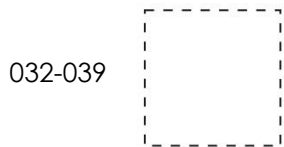
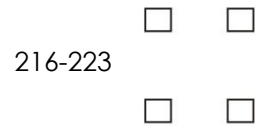
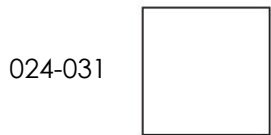
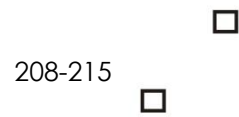
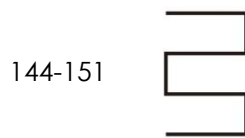
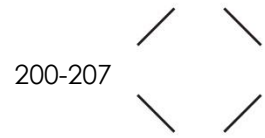
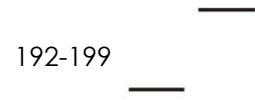
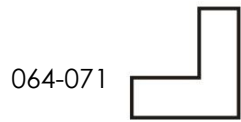
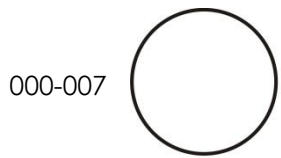

Maintenance

The Showtec Galactic B400 requires almost no maintenance. However, you should keep the unit clean. Otherwise, the fixture's light-output will be significantly reduced. Disconnect the mains power supply, and then wipe the cover with a damp cloth. Do not immerse in liquid. Wipe lens clean with glass cleaner and a soft cloth. Do not use alcohol or solvents. Keep connections clean. Disconnect electric power, and then wipe the connections with a damp cloth. Make sure connections are thoroughly dry before linking equipment or supplying electric power.

The operator has to make sure that safety-relating and machine-technical installations are to be inspected by an expert after every four years in the course of an acceptance test.

The operator has to make sure that safety-relating and machine-technical installations are to be inspected by a skilled person once a year.

The following points have to be considered during the inspection:

1. All screws used for installing the device or parts of the device have to be tightly connected and must not be corroded.
2. There may not be any deformations on housings, fixations and installation spots.
3. Mechanically moving parts like axles, eyes and others may not show any traces of wearing.
4. The electric power supply cables must not show any damages or material fatigue.

Replacing a Fuse

Power surges, short-circuit or inappropriate electrical power supply may cause a fuse to burn out. If the fuse burns out, the product will not function whatsoever. If this happens, follow the directions below to do so.

1. Unplug the unit from electric power source.
2. Insert a screwdriver into the slot in the fuse cover. Gently pry up the fuse cover. The fuse will come out.
3. Remove the used fuse. If brown or unclear, it is burned out.
4. Insert the replacement fuse into the holder where the old fuse was. Reinsert the fuse cover. Be sure to use a fuse of the same type and specification. See the product specification label for details.

Troubleshooting

This troubleshooting guide is meant to help solve simple problems.

If a problem occurs, carry out the steps below in sequence until a solution is found. Once the unit operates properly, do not carry out following steps.

1. If the device does not operate properly, unplug the device.
2. Check the power from the wall, the fuse, all cables etc.
3. If all of the above appears to be O.K., plug the unit in again.
4. If you are unable to determine the cause of the problem, do not open the Galactic B400, as this may damage the unit and the warranty will become void.
5. Return the machine to your Showtec dealer.

No Light

This troubleshooting guide is meant to help solve simple problems. If a problem occurs, carry out the steps below in sequence until a solution is found. Once the unit operates properly, do not carry out following steps. If the laser effect does not operate properly, refer servicing to a technician.

Response: Suspect three potential problem areas: the power supply, the laser, the fuse.

1. Power supply. Check that the unit is plugged into an appropriate power supply.
2. The laser. Return the device to your Showtec dealer.
3. The fuse. See page 18 for replacing the fuse.

No Response to DMX

Response: Suspect the DMX cable or connectors, a controller malfunction, a light effect DMX card malfunction.

1. Check the DMX cable: Unplug the unit; change the DMX cable; then reconnect to electrical power. Try your DMX control again.
2. Determine whether the controller or light effect is at fault. Does the controller operate properly with other DMX products? If not, take the controller in for repair. If so, take the DMX cable and the light effect to a qualified technician.

See next page for more problem solving.

Problem	Probable cause(s)	Remedy
One or more fixtures are completely dead.	No power to the fixture	<ul style="list-style-type: none"> • Check that power is switched on and cables are plugged in.
	Primary fuse blown.	<ul style="list-style-type: none"> • Replace fuse.
Fixtures reset correctly, but all respond erratically or not at all to the controller.	The controller is not connected.	<ul style="list-style-type: none"> • Connect controller.
	3-pin XLR Out of the controller does not match XLR Out of the first fixture on the link (i.e. signal is reversed).	<ul style="list-style-type: none"> • Install a phase reversing cable between the controller and the first fixture on the link.
Fixtures reset correctly, but some respond erratically or not at all to the controller.	Poor data quality	<ul style="list-style-type: none"> • Check data quality. If much lower than 100 percent, the problem may be a bad data link connection, poor quality or broken cables, missing termination plug, or a defective fixture disturbing the link.
	Bad data link connection	<ul style="list-style-type: none"> • Inspect connections and cables. Correct poor connections. Repair or replace damaged cables.
	Data link not terminated with 120 Ohm termination plug.	<ul style="list-style-type: none"> • Insert termination plug in output jack of the last fixture on the link.
	Incorrect addressing of the fixtures.	<ul style="list-style-type: none"> • Check address setting.
	One of the fixtures is defective and disturbs data transmission on the link.	<ul style="list-style-type: none"> • Bypass one fixture at a time until normal operation is regained: unplug both connectors and connect them directly together. • Have the defective fixture serviced by a qualified technician.
	3-pin XLR Out on the fixtures does not match (pins 2 and 3 reversed).	<ul style="list-style-type: none"> • Install a phase-reversing cable between the fixtures or swap pin 2 and 3 in the fixture, that behaves erratically.
No laser	The power supply settings do not match local AC voltage and frequency.	<ul style="list-style-type: none"> • Disconnect fixture. Check settings and correct if necessary.
	Laser damaged.	<ul style="list-style-type: none"> • Disconnect fixture. Check settings and correct if necessary.

Product Specification

Model: Showtec Galactic B400

- When using multiple units together, you can make a great and cost effective beam-show
- Power Input: AC 100-240V, 50/60Hz
- Power Consumption: 12 Watt
- Beam Diameter <5mm at aperture
- Pulse Data All pulses < 4Hz (>0.25sec)
- Divergence (each beam) <2 mrad
- Divergence (total light) <40 degrees
- Laser Class: III B
- Laser Safety: EN/IEC 60825-1 Ed 2, 2007-03
- Laser Power: 400mW, DPSS Medium LD GeAs, wavelength 450 nm / Blue
- Scan Angle: +/-30°
- Scan Speed: Stepping motor
- Control Modes: Auto, Sound, Master/Slave, DMX
- 3-pin DMX In and 3-pin DMX Out
- Clear LCD display for all settings
- Compact strong metal housing
- Music-controlled via built-in microphone
- 8 DMX Channels
- Safety Features: Key switch, Interlock, Safety eye
- Fuse 1A / 250V
- Dimensions: 145 x 160 x 80mm (excl. bracket)
- Weight: 1.28 Kg



Minimum distance:

Minimum distance from flammable surfaces: 0.5m
Minimum distance to lighted object: 0.8m



Design and product specifications are subject to change without prior notice.



Website: www.Showtec.info
Email: service@highlite.nl



© 2013 Showtec.