

LUXFORM
LIGHTING

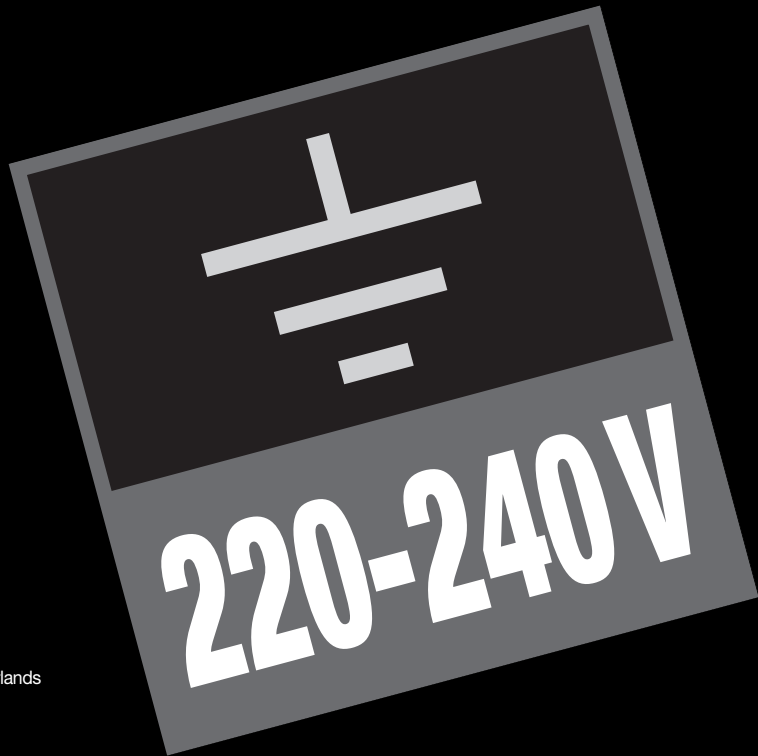

LUXFORM
GLOBAL BV

Luxform Global BV Transportstraat 1 8263 BW Kampen The Netherlands

© Copyright 2010 Luxform Global BV GB002227

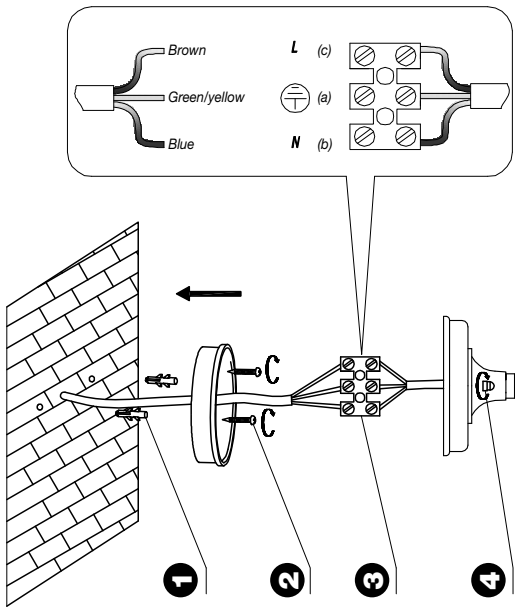

Orlando

hanging chain lantern

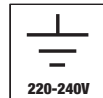

P14



P15

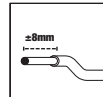

C11

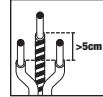

C12

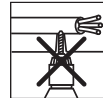

C13



C14



L1



L11

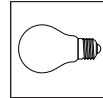

L24

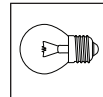

L25



L27



M2



M5

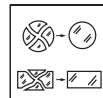

M12



M18



M19

