

# MULTIBEAM LASER

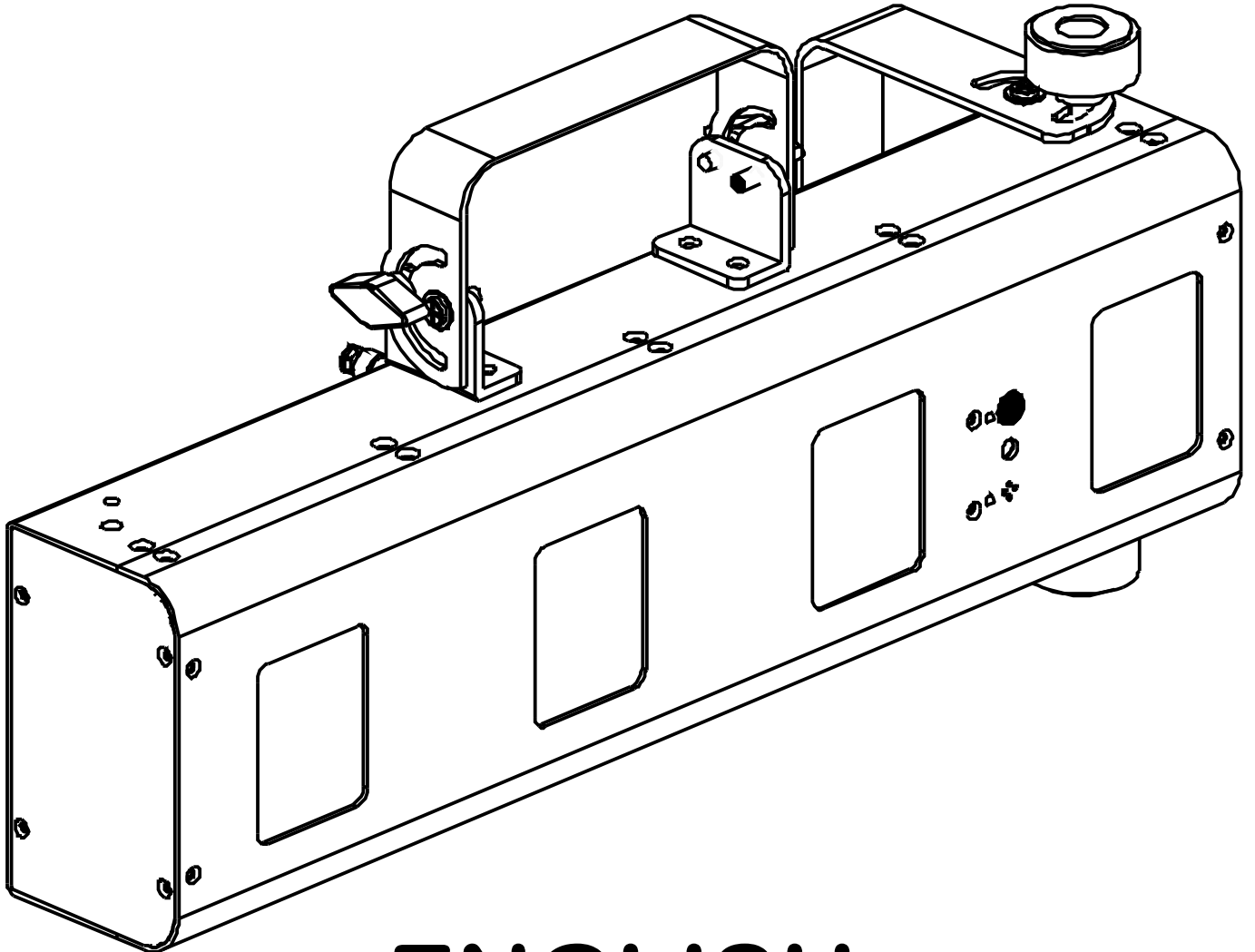

## ENGLISH Operation Manual

Other languages can be downloaded from:  
[WWW.JB-SYSTEMS.EU](http://WWW.JB-SYSTEMS.EU)

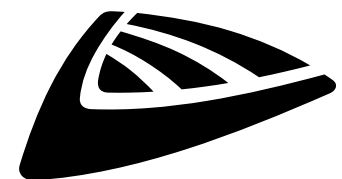

*Version: 3.1*

**JB SYSTEMS**



### **EN - DISPOSAL OF THE DEVICE**

Dispose of the unit and used batteries in an environment friendly manner according to your country regulations.

### **FR - DÉCLASSER L'APPAREIL**

Débarrassez-vous de l'appareil et des piles usagées de manière écologique Conformément aux dispositions légales de votre pays.

### **NL - VERWIJDEREN VAN HET APPARAAT**

Verwijder het toestel en de gebruikte batterijen op een milieuvriendelijke manier conform de in uw land geldende voorschriften.

### **DU - ENTSORGUNG DES GERÄTS**

Entsorgen Sie das Gerät und die Batterien auf umweltfreundliche Art und Weise gemäß den Vorschriften Ihres Landes.

### **ES - DESHACERSE DEL APARATO**

Reciclar el aparato y pilas usadas de forma ecologica conforme a las disposiciones legales de su país.

### **PT - COMO DESFAZER-SE DA UNIDADE**

Tente reciclar a unidade e as pilhas usadas respeitando o ambiente e em conformidade com as normas vigentes no seu país.

# OPERATION MANUAL

Thank you for buying this JB Systems® product. To take full advantage of all possibilities and for your own safety, please read these operating instructions very carefully before you start using this unit.

## FEATURES

- A superb 850 mWatt Class-3B RGRB color laser equipped with 4 powerful, temperature controlled lasers:
  - 2 x 150mW Red laser (650nm)
  - 1 x 50mW Green laser (532nm)
  - 1 x 500mW Blue laser (450nm)
- The 4 user modes make this laser very easy to use:
  - **MUSIC CONTROL:** 100% plug & play, just connect the laser to the mains to start an incredible, music controlled, laser show based on the internal patterns! Perfect for hiring companies!!!
  - **MASTER/SLAVE mode:** Several units can be used in completely synchronized music mode: amazing and very simple to use!
  - **AUTOMATIC mode:** all internal programs will be shown automatically, no music needed. Depending your needs you can choose a fast or soft show.
  - **DMX mode:** two options possible:
    - 2 channel for extremely easy setup and use!
    - 10 channels to take full control of all internal programs!
- LED-display for easy navigation in the setup menu.
- Perfect for use in clubs, discotheques, mobile DJ's and many more ...
- **Prepared for wireless DMX:** just plug-in an optional WTR-DMX DONGLE ! (Briteq® order code: 4645)
- **SAFETY FIRST!** Class-3B lasers (more than 500mW output) can damage the human eye very badly so never buy such high power laser without checking if it passed the severe laser safety tests! This laser complies to the European EN 60825-1:2014 for Laser Safety! It is equipped with extra safety measures like:
  - **Interlock connection with mechanical shutter:** press the safety switch to shut down the output.
  - **Key switch:** only authorized and well trained operators are allowed to use the laser.

## BEFORE USE

- Before you start using this unit, please check if there's no transportation damage. Should there be any, do not use the device and consult your dealer first.
- **Important:** This device left our factory in perfect condition and well packaged. It is absolutely necessary for the user to strictly follow the safety instructions and warnings in this user manual. Any damage caused by mishandling is not subject to warranty. The dealer will not accept responsibility for any resulting defects or problems caused by disregarding this user manual.
- Keep this booklet in a safe place for future consultation. If you sell the fixture, be sure to add this user manual.

### Check the contents:

Check that the carton contains the following items:

- MULTIBEAM LASER
- 2 keys (for key switch)
- Mains cable
- Operating instructions
- Cable connector for remote interlock

## SAFETY INSTRUCTIONS:



**CAUTION**  
RISK OF ELECTRIC SHOCK  
DO NOT OPEN



**CAUTION:** To reduce the risk of electric shock, do not remove the top cover. No user-serviceable parts inside. Refer servicing to qualified service personnel only.



The lightning flash with arrowhead symbol within the equilateral triangle is intended to alert the user of the presence of un-insulated "dangerous voltage" within the product's enclosure that may be of sufficient magnitude to constitute a risk of electric shock.



The exclamation point within the equilateral triangle is intended to alert the user to the presence of important operation and maintenance (servicing) instructions in the literature accompanying this appliance.



This symbol means: indoor use only.



This symbol means: Read instructions.



This symbol determines: the minimum distance from lighted objects. The minimum distance between light-output of this laser and the illuminated surface must be more than 2.5 meters.

- To protect the environment, please try to recycle the packing material as much as possible.
- A new light effect sometimes causes some unwanted smoke and/or smell. This is normal and disappears after some minutes.
- To prevent fire or shock hazard, do not expose this appliance to rain or moisture.
- To avoid condensation to be formed inside, allow the unit to adapt to the surrounding temperatures when bringing it into a warm room after transport. Condense sometimes prevents the unit from working at full performance or may even cause damages.
- This unit is for indoor use only.
- Don't place metal objects or spill liquid inside the unit. Electric shock or malfunction may result. If a foreign object enters the unit, immediately disconnect the mains power.
- Locate the fixture in a well ventilated spot, away from any flammable materials and/or liquids. The fixture must be fixed at least 50cm from surrounding walls.
- Don't cover any ventilation openings as this may result in overheating.
- Prevent use in dusty environments and clean the unit regularly.
- Keep the unit away from children.
- Inexperienced persons should not operate this device.
- Maximum save ambient temperature is 40°C. Don't use this unit at higher ambient temperatures.
- Make sure the area below the installation place is free from unwanted persons during rigging, de-rigging and servicing.
- Allow the device about 10 minutes to cool down before servicing.
- Always unplug the unit when it is not used for a longer time or before replacing the bulb or start servicing.
- The electrical installation should be carried out by qualified personal only, according to the regulations for electrical and mechanical safety in your country.
- Check that the available voltage is not higher than the one stated on the rear panel of the unit.
- The power cord should always be in perfect condition. Switch the unit immediately off when the power cord is squashed or damaged. It must be replaced by the manufacturer, its service agent or similarly qualified persons in order to avoid a hazard.
- Never let the power-cord come into contact with other cables!
- This fixture must be earthed to in order comply with safety regulations.
- Don't connect the unit to any dimmer pack.
- Always use an appropriate and certified safety cable when installing the unit.
- In order to prevent electric shock, do not open the cover. Apart from the lamp and mains fuse there are no user serviceable parts inside.
- **Never** repair a fuse or bypass the fuse holder. **Always** replace a damaged fuse with a fuse of the same type and electrical specifications!
- In the event of serious operating problems, stop using the fixture and contact your dealer immediately.
- The housing and the lenses must be replaced if they are visibly damaged.
- Please use the original packing when the device is to be transported.
- Due to safety reasons it is prohibited to make unauthorized modifications to the unit.

**Important:** Never look directly into the light source! Don't use the effect in the presence of persons suffering from epilepsy.

# LASER SAFETY INSTRUCTIONS:

- According to the EN 60825-1:2014 regulations, this laser falls under the classification 3B. Direct eye exposure can be dangerous.



**DANGER: LASER RADIATION !**  
 Avoid direct eye exposure! Laser radiation can cause eye damage and/or skin damage. All protective measures for a safe operation of this laser must be applied.



- This product is a so-called show laser, emitting radiation with a wavelength spectrum between 400 and 700 nm and producing lighting effects for shows.
- Due to the construction of this laser, the beam is moved so fast, that it can only hit the eye very short. This is why the use of this laser for a Laser-Light-Show can be regarded as safe.
- Never direct the laser beam to people or animals and never leave this device running unattended.
- This laser may only be used for shows. The operation of this class 3B show laser is only allowed if it is done by a professional operator.
- Depending on the classification, operating a laser product can produce laser radiation that may cause permanent eye damage and/or skin damage. The legal instructions for using a laser product vary from country to country. The user must always inform himself on the legal instructions valid in his country and apply them to his situation.

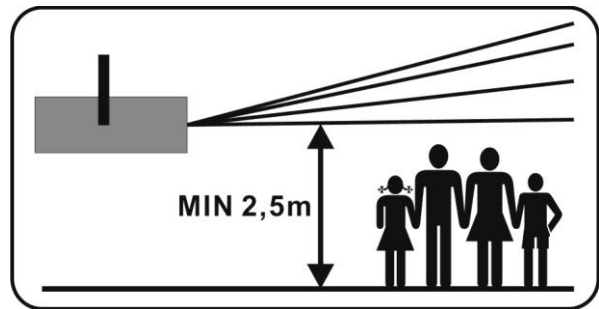

Please note that **JB Systems** cannot be made liable for damages caused by incorrect installations and unskilled operation!

## WARNING LABEL LOCATIONS

### A. APERTURE logos



These warning labels indicate the laser emission aperture on the device: the emitted laser light is potentially dangerous. NEVER look directly into the laser beam. Risk of eye injury and / or blinding!

### B. WARNING logo

WARNING – CLASS 3B LASER RADIATION WHEN OPEN. Avoid exposure to the beam.

### C. Multilingual warning sticker

Warning – laser radiation, avoid exposure to beam.  
 Class 3B laser product.  
 IEC/EN 60825-1:2014  
 Wavelength: 50mW Green CW laser ( $\lambda = 532\text{nm}$ )  
 2 x 150mW Red CW laser ( $\lambda = 650\text{nm}$ )  
 500mW Blue CW laser ( $\lambda = 450\text{nm}$ )  
 Laser radiation: CW <500mW

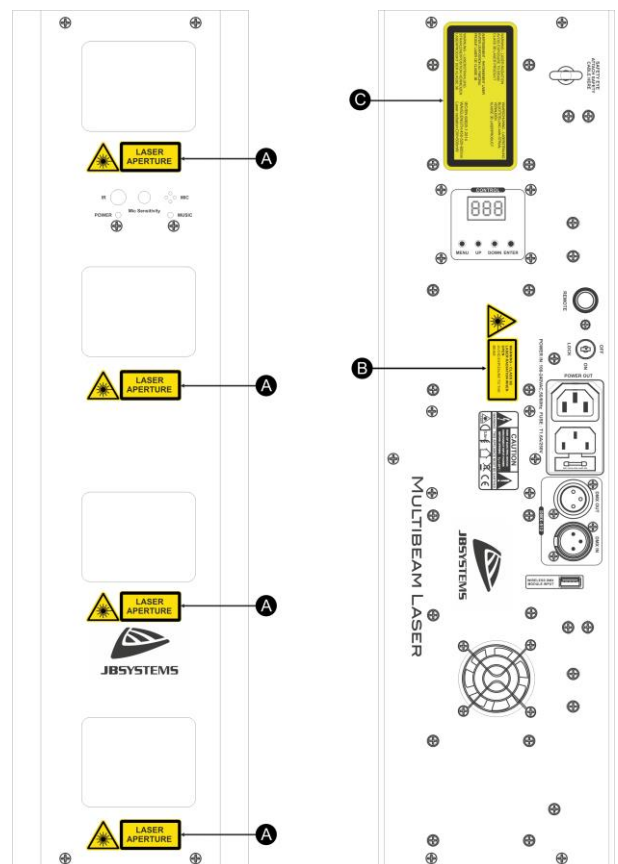



**DESCRIPTION:**

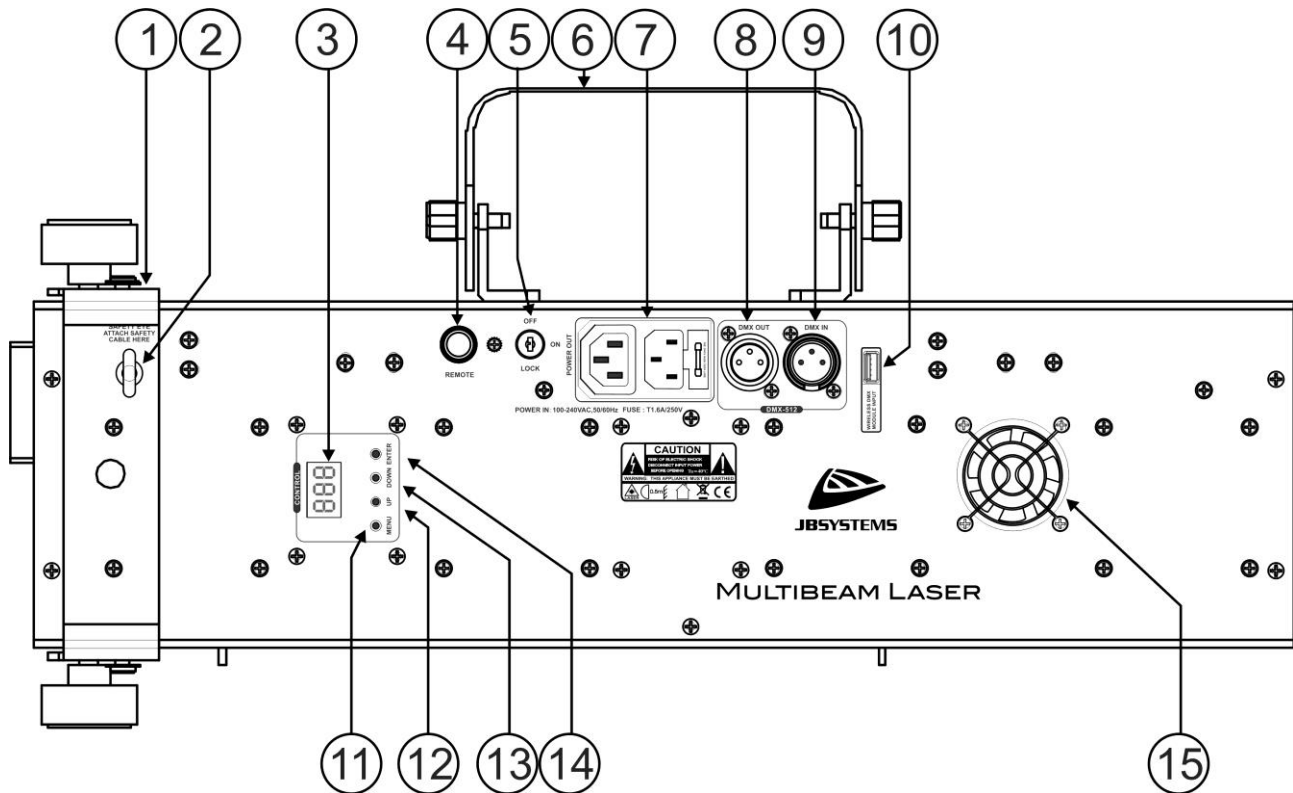

1. **HANGING BRACKET** : for hanging the Multibeam Laser in vertical position.
2. **SAFETY EYE**: used to attach a safety cable when the unit is rigged (see paragraph “overhead rigging”)
3. **DISPLAY**: shows the different working modes with their respective options and settings.
4. **INTERLOCK input**: used to connect the optional emergency stop switch (see picture). When you push this switch it will activate the mechanical safety shutter so the laser beam will disappear immediately.  
**IMPORTANT! For your own safety we strongly recommend to connect this optional switch!**
5. **ON/OFF KEY ACTIVATED SWITCH**: used to switch the laser beam on/off. Use the keys to make sure only an authorized operator is able to switch the laser on.
6. **HANGING BRACKET**: for hanging the Multibeam Laser in horizontal position.
7. **MAINS IN- AND OUTPUT**: with IEC socket and integrated fuse holder, connect the supplied mains cable here and link a second Multibeam Laser (you can use our JB Systems combi cable IEC/XLR)
8. **DMX OUTPUT**: 3pin female XLR-connector used to connect the laser with the next unit in the DMX chain.
9. **DMX INPUT**: 3pin male XLR-connector used to connect universal DMX-cables. This input receives



instructions from a DMX-controller.

10. **M-DMX INPUT:** Please note that this USB-connector is NOT used for updates or to connect the unit to a PC! Instead this USB-connector makes it very easy to add wireless DMX to the unit! Just add the (optional) WTR-DMX DONGLE from BRITEQ® and you will get wireless DMX! Moreover you will be able to connect other DMX-controlled equipment to the DMX-output so you can share the wireless DMX function with all connected units! No extra settings to be made in the setup menu, just follow the procedure in the user manual supplied with the WTR-DMX DONGLE from BRITEQ®. *The separate WTR-DMX DONGLE is available from WWW.BRITEQ-LIGHTING.COM (order code: 4645)*
11. **MENU BUTTON:** used to browse the different functions and working modes in the menu.
12. **UP BUTTON:** used to go to the upper option or to increase a parameter of a function or working mode.
13. **DOWN BUTTON:** used to go to a lower option or to decrease a parameter of a function or working mode
14. **ENTER BUTTON:** Used to confirm the selected value or function that is shown on the display.
15. **COOLING FAN:** used to cool the components inside the enclosure. Make sure to never cover this fan outlet!
16. **POWER LED :** Indicates that the unit is switched on.
17. **MUSIC LED :** in music mode this LED blinks to the rhythm of the music.
18. **MIC :** The built-in microphone is used to synchronize the laser show to the beat of the music.
19. **MIC SENSITIVITY :** This potentiometer is used to adjust the music input sensitivity. Turn the potentiometer until the laser works in sync with the music.
20. **IR :** IR-sensor, used to control the unit by the wireless IR remote control.

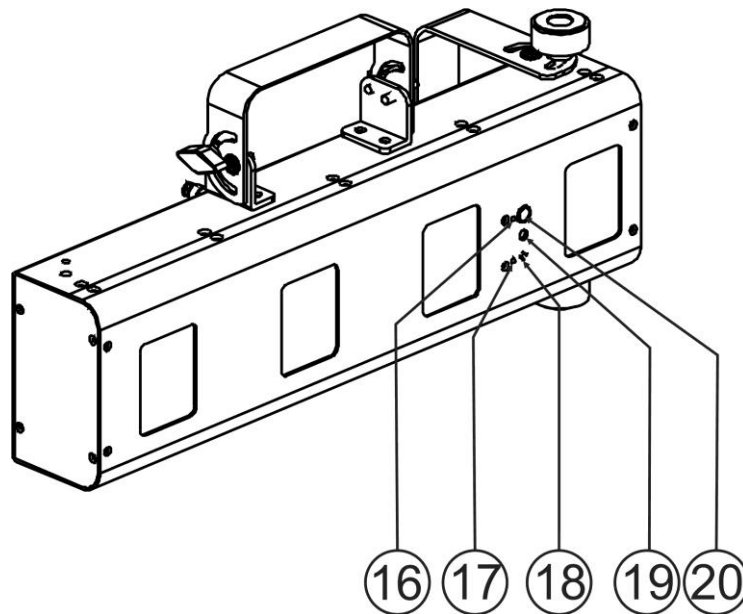

## OVERHEAD RIGGING

- **Important:** The installation must be carried out by qualified service personal only. Improper installation can result in serious injuries and/or damage to property. Overhead rigging requires extensive experience! Working load limits should be respected, certified installation materials should be used, the installed device should be inspected regularly for safety.
- Make sure the area below the installation place is free from unwanted persons during rigging, de-rigging and servicing.
- Locate the fixture in a well ventilated spot, far away from any flammable materials and/or liquids. The fixture must be fixed **at least 50cm** from surrounding walls.
- The device should be installed out of reach of people and outside areas where persons may walk by or be seated.
- Before rigging make sure that the installation area can hold a minimum point load of 10times the device's weight.

- Always use a certified safety cable that can hold 12 times the weight of the device when installing the unit. This secondary safety attachment should be installed in a way that no part of the installation can drop more than 20cm if the main attachment fails.
- The device should be well fixed; a free-swinging mounting is dangerous and may not be considered!
- Don't cover any ventilation openings as this may result in overheating.
- The operator has to make sure that the safety-relating and machine-technical installations are approved by an expert before using them for the first time. The installations should be inspected every year by a skilled person to be sure that safety is still optimal.



**CAUTION EYEDAMAGE:** Always position the laser in a way that prevents the audience from looking directly into the laser beams. The installation should assure that the beam will not strike the audience.

## HOW TO SET UP AND CONTROL THE UNIT

- Regular breaks during operation are essential to maximize the life of this device as it is not designed for continual use.
- Do not switch the unit on and off in short time intervals as this reduces the lifetime of the lasers.
- Always unplug the unit when it is not used for a longer time.
- In the event of serious operating problems, stop using the fixture and contact your dealer immediately.
- **Important:** Never look directly into the laser beam! Don't use the effect in the presence of persons suffering from epilepsy.

### ! IMPORTANT INFORMATION – READ BEFORE USE !

This laser contains 3 different lasers. One of the lasers is a GREEN 532nm DPSS LASER (Diode Pumped Solid State laser).

**DPSS lasers need a warmup period of about 5-15 minutes to reach a stable working temperature.**

During warmup the power output and beam undergo large fluctuations, sometimes the green laser beam will only appear after some minutes. As the warm-up progresses DPSS lasers become more and more stable until they finally reach the optimum temperature for operation. **This is normal with all DPSS lasers and is not a defect.**

Best ambient temperature is +/- 20° to 35°C

### You can operate the unit in several ways:

#### 1) STANDALONE MODE USING THE BUILD-IN PROGRAMS:

The laser runs a preprogrammed sequence automatically or to the rhythm of the music. Select this mode when only 1 laser is used (standalone) or when the laser is placed as the first (master) unit in a chain with several [MULTIBEAM LASER] lasers (master/slave mode).

- Press the [MENU]-button until the display shows [P--]
- Press [Enter] to select the preprogrammed shows [P 1 ... P 12]
- Press the [UP / DOWN] buttons to choose one of the shows.
- Press [Enter] to confirm the selected show.

#### 2) STANDALONE MODE USING THE BUILD-IN PROGRAMS (MUSIC CONTROLLED):

- Press the [MENU]-button until the display shows [Sn1]
- Press the [ENTER]-button to confirm your choice.
- Put on some music and adjust the [MUSIC SENSITIVITY]-knob (18) until the laser works nicely to the rhythm of the music.

**Note:** When no music is detected, the laser output will be shut off (blackout).

#### 3) MASTER/SLAVE MODE:

You can connect several [MULTIBEAM LASER] lasers together.

Connect the DMX input of the first laser to the DMX output of the previous laser in the chain.

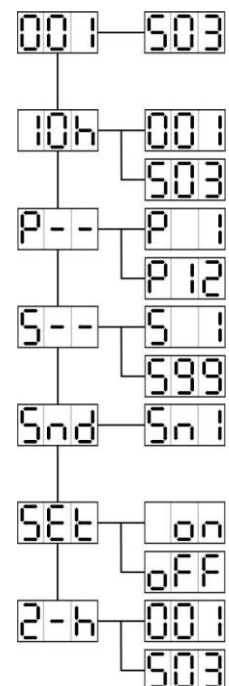



Please put the first unit of the chain in “Music or automatic mode” and all the other units in [2-h] or [10h] mode.

The lasers will follow the instructions given by the first [MULTIBEAM laser] (master) in the chain.

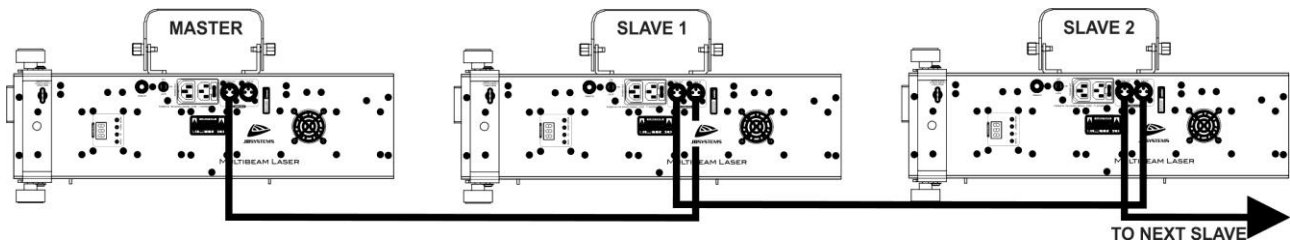

**4) DMX MODE:**

The laser can be controlled by any standard DMX-controller in 2 different DMX-modes:

- **2 CHANNEL MODE:** for extremely easy setup and use! (display shows “2-h”)
- **10 CHANNEL MODE:** for full control of all possibilities. (display shows “10h”)
- Connect the DMX input of the laser to the DMX output of the previous unit in the chain or directly to the DMX-output of your controller.
- Press the [MENU] button to select the desired DMX-mode. (2-h or 10h)
- Press the [ENTER]-button to confirm your choice.
- Press the [UP / DOWN] buttons to choose the desired DMX-address (from 001 to 503 (10h) or 001 to 511 (2-h))
- Press the [ENTER]-button to confirm your choice.

Please refer to the DMX-chart below for the functions of the different channels.

**Some more information on DMX512:**

The DMX-protocol is a widely used high speed signal to control intelligent light equipment. You need to “daisy chain” your DMX controller and all the connected light effects with a good quality XLR M/F balanced cable. To prevent strange behavior of the light effects, due to interferences, you must use a 90Ω to 120Ω terminator at the end of the chain. Never use Y-splitter cables, this simply won’t work!



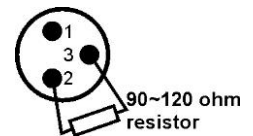



Each effect in the chain needs to have its proper starting address so it knows which commands from the controller it has to decode.



**2 channel DMX MODE:**

CHANNEL	VALUE	FUNCTION
<b>CH 1</b>	000-015	Blackout
	016-035	Program 1
	036-055	Program 2
	056-075	Program 3
	076-095	Program 4
	096-115	Program 5
	116-135	Program 6
	136-155	Program 7
	156-175	Program 8
	176-195	Program 9
	196-215	Program 10
	216-235	Program 11
236-255	Program 12	
<b>CH 2</b>	000-200	Program speed
	201-255	Programs will run sound activated

10 channel DMX MODE:

CHANNEL	VALUE	FUNCTION	
CH 1	000-015	Channel 3-10 are active	
	016-255	See 2-channel DMX mode	
CH 2	000-200	Program speed	
	201-255	Programs run sound activated	
CH 3	000-015	Blackout	
	016-255	Control four laser outputs	
CH 4	000-255	Patterns	
CH 5	000-127	Pattern size : 100%-5%	
	128-169	Zooming in	
	170-209	Zooming out	
	210-255	Zooming in & out	
CH 6	000-127	0 -359 degree fixed X axis rolled	
	128-191	Clockwise rolling	
	192-255	Anticlockwise rolling	
CH 7	000-127	0 -359 degree fixed Y axis rolled	
	128-191	Clockwise rolling	
	192-255	Anticlockwise rolling	
CH 8	000-127	0 -359 degree fixed Z axis rotate	
	128-191	Clockwise rotating	
	128-255	Anticlockwise rotating	
CH 9	000-127	128 different fixed position on X	
	128-191	Clockwise moving	
	128-255	Anticlockwise moving	
CH 10	000-127	128 different fixed position on Y	
	128-191	Clockwise moving	
	128-255	Anticlockwise moving	

5) IR Remote control:

The laser can also be controlled by the IR remote control:

- Press the [MENU] button to select the correct mode [SET]
- Press the [ENTER]-button to confirm your choice.
- Press the [UP / DOWN] buttons to choose [on] or [off] to enable or disable the IR remote control
- Press the [ENTER]-button to confirm your choice.

ON/OFF : Blackout

AUTO : runs programs in automatic mode

MUSIC : runs programs in sound controlled mode

 : Speed up (faster)

 : Speed down

1 – 9 : program 1 – 9

The other buttons have no function.



## MAINTENANCE

- Make sure the area below the installation place is free from unwanted persons during servicing.
- Switch off the unit, unplug the mains cable and wait until the unit has been cooled down.

**During inspection the following points should be checked:**

- All screws used for installing the device and any of its parts should be tightly fastened and may not be corroded.
- Housings, fixations and installations spots (ceiling, truss, suspensions) should be totally free from any deformation.
- When an optical lens is visibly damaged due to cracks or deep scratches, it must be replaced.
- The mains cables must be in impeccable condition and should be replaced immediately when even a small problem is detected.
- In order to protect the device from overheat the cooling fans and ventilation openings should be cleaned monthly.
- The interior of the device should be cleaned annually by experienced service people.

**Attention: We strongly recommend internal cleaning to be carried out by qualified personnel only!**

## SPECIFICATIONS

This unit is radio-interference suppressed. This product meets the requirements of the current European and national guidelines. Conformity has been established and the relevant statements and documents have been deposited by the manufacturer.

<b>Mains Input:</b>	AC 100~240V, 50/60Hz
<b>Fuse:</b>	250V 1.6A slow blow (20mm glass)
<b>Total Power consumption:</b>	65W
<b>Sound Control:</b>	Internal microphone
<b>DMX connections:</b>	3pin XLR male / female
<b>DMX channels:</b>	2 or 10 channels
<b>DMX starting address:</b>	001 → 503/511 (10 channel or 2 channel mode)
<b>Laser Power:</b>	50mW Green CW laser ( $\lambda = 532\text{nm}$ ) 2 x 150mW Red CW laser ( $\lambda = 650\text{nm}$ ) 500mW Blue CW laser ( $\lambda = 450\text{nm}$ )
<b>MPE / NOHD:</b>	Not relevant, the beam is continuously scattered and moves in all directions (no stationary laser beam)
<b>Laser radiation class:</b>	Class 3B
<b>Laser Safety Standard:</b>	EN 60825-1:2014 for Laser Safety
<b>Size (WxHxD):</b>	53,7cm x 26,8cm x 17cm
<b>Weight:</b>	5.05kg

Every information is subject to change without prior notice.

You can download the latest version of this user manual on our website: [www.jb-systems.eu](http://www.jb-systems.eu)



**JB SYSTEMS**

## **MAILING LIST**

**EN: Subscribe today to our mailing list for the latest product news!**

**FR: Inscrivez-vous à notre liste de distribution si vous souhaitez suivre l'actualité de nos produits!**

**NL: Abonneer je vandaag nog op onze mailinglijst en ontvang ons laatste product nieuws!**

**DE: Abonnieren Sie unseren Newsletter und erhalten Sie aktuelle Produktinformationen!**

**ES: Suscríbete hoy a nuestra lista de correo para recibir las últimas noticias!**

**PT: Inscreva-se hoje na nossa mailing list para estar a par das últimas notícias!**

**[WWW.JB-SYSTEMS.EU](http://WWW.JB-SYSTEMS.EU)**

**Copyright © 2020 by BEGLEC NV**

t Hofveld 2C ~ B1702 Groot-Bijgaarden ~ Belgium

Reproduction or publication of the content in any manner, without express permission of the publisher, is prohibited.