

EQUINOX

Truss Booth Quad LED Starcloth System

User Manual

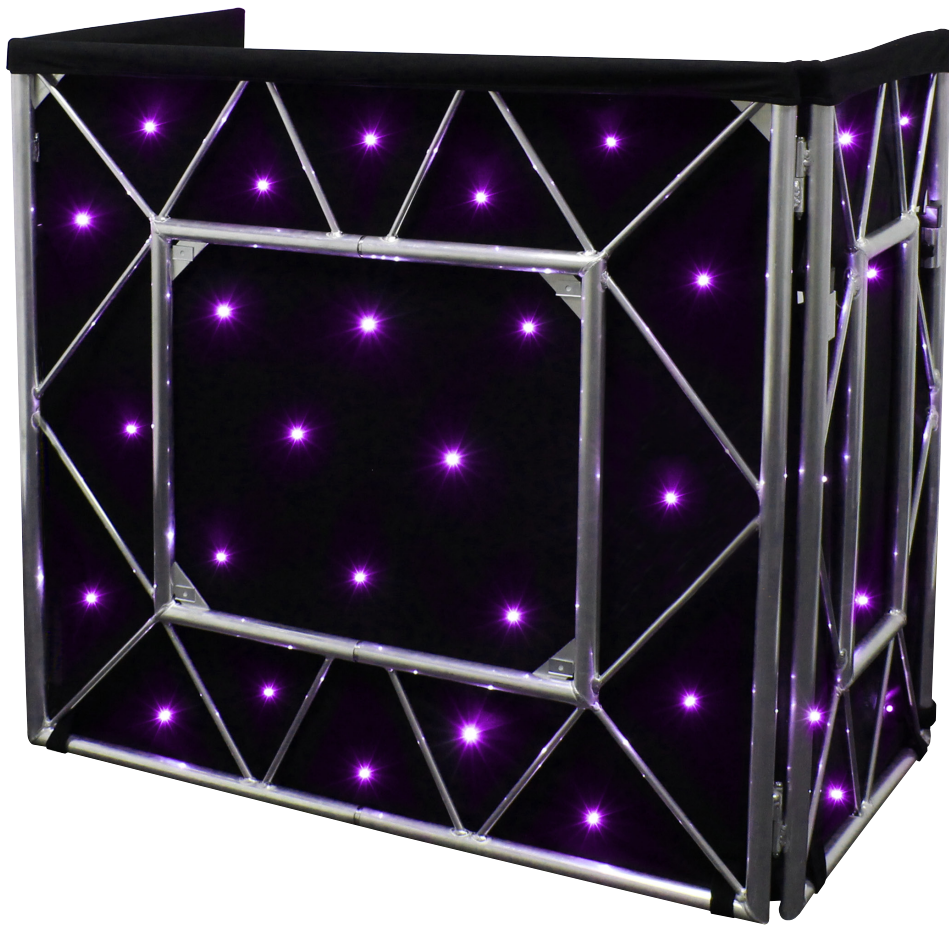

Order code: EQLED150N

WARNING - FOR YOUR OWN SAFETY, PLEASE READ THIS USER MANUAL CAREFULLY BEFORE YOUR INITIAL START-UP!

- Before your initial start-up, please make sure that there is no damage caused during transportation.
- Should there be any damage, consult your dealer and do not use the equipment.
- To maintain the equipment in good working condition and to ensure safe operation, it is necessary for the user to follow the safety instructions and warning notes written in this manual.
- Please note that damages caused by user modifications to this equipment are not subject to warranty.



IMPORTANT:

The manufacturer will not accept liability for any resulting damages caused by the non-observance of this manual or any unauthorised modification to the equipment.

- Never let the power cable come into contact with other cables. Handle the power cable and all mains voltage connections with particular caution!
 - Never remove warning or informative labels from the unit.
 - Do not open the equipment and do not modify the unit.
 - Do not connect this equipment to a dimmer pack.
 - Do not switch the equipment on and off in short intervals, as this will reduce the system's life.
 - Only use the equipment indoors.
 - Do not expose to flammable sources, liquids or gases.
 - Always disconnect the power from the mains when equipment is not in use or before cleaning! Only handle the power-cable by the plug. Never pull out the plug by pulling the power-cable.
 - Make sure that the available mains supply voltage is between 100~240V AC, 50/60Hz.
 - Make sure that the power cable is never crimped or damaged. Check the equipment and the power cable periodically.
 - If the equipment is dropped or damaged, disconnect the mains power supply immediately and have a qualified engineer inspect the equipment before operating again.
 - If the equipment has been exposed to drastic temperature fluctuation (e.g. after transportation), do not connect power or switch it on immediately. The arising condensation might damage the equipment.
- Leave the equipment switched off until it has reached room temperature.
- If your product fails to function correctly, stop use immediately. Pack the unit securely (preferably in the original packing material), and return it to your Pro Light dealer for service.
 - Only use fuses of same type and rating.
 - To clean the cloth, disconnect the mains power supply and then wipe with a damp cloth. Do not immerse in liquid. The cloth will require monthly cleaning. Do not use alcohol or solvents. Connections and LEDs must be kept clean and dry at all times.
 - Repairs, servicing and power connection must only be carried out by a qualified technician. THIS UNIT CONTAINS NO USER SERVICEABLE PARTS.
 - This starcloth and/or controller is for professional use only - it is not designed for or suitable for household use. The product must be installed by a qualified technician in accordance with local territory regulations. The safety of the installation is the responsibility of the installer. The fixture presents risks of severe injury or death due to fire hazards, electric shock and falls.
 - Warning! Risk Group 2 LED product according to EN 62471. Do not view the light output with optical instruments or any device that may concentrate the beam.
 - WARRANTY: One year from date of purchase.

OPERATING DETERMINATIONS

If this equipment is operated in any other way, than those described in this manual, the product may suffer damage and the warranty becomes void. Incorrect operation may lead to danger e.g: short-circuit, burns and electric shocks etc.

Do not endanger your own safety and the safety of others!

Incorrect installation or use can cause serious damage to people and/or property.

Truss Booth Quad LED Starcloth System

Featuring 48 quad-colour 5050 LEDs, this DJ Booth starcloth comes supplied with an advanced DMX controller. The controller features solid colour selection coupled with pattern and speed control, allowing the DJ to match the starcloth colour to any other room lighting. Supplied with heavy duty carry bag.

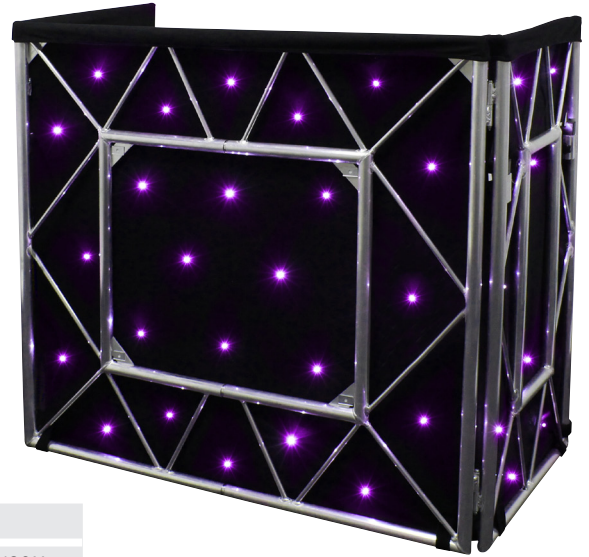

Cloth:

- 48 quad-colour 5050 LEDs (RGBW)
- Fast fixx™ velcro tabs
- Low reflection, fire retardant material
- Includes an advanced DMX controller
- Carry bag included

Controller:

- DMX channels: 3, 9 or 28 selectable
- Static colour, auto, DMX, sound active and master/slave modes
- IEC power input
- 3-Pin XLR input/output

Specifications	Controller
Power supply	100~240V, 50/60Hz
Fuse	T1A 250V
Dimensions	55 x 205 x 145mm

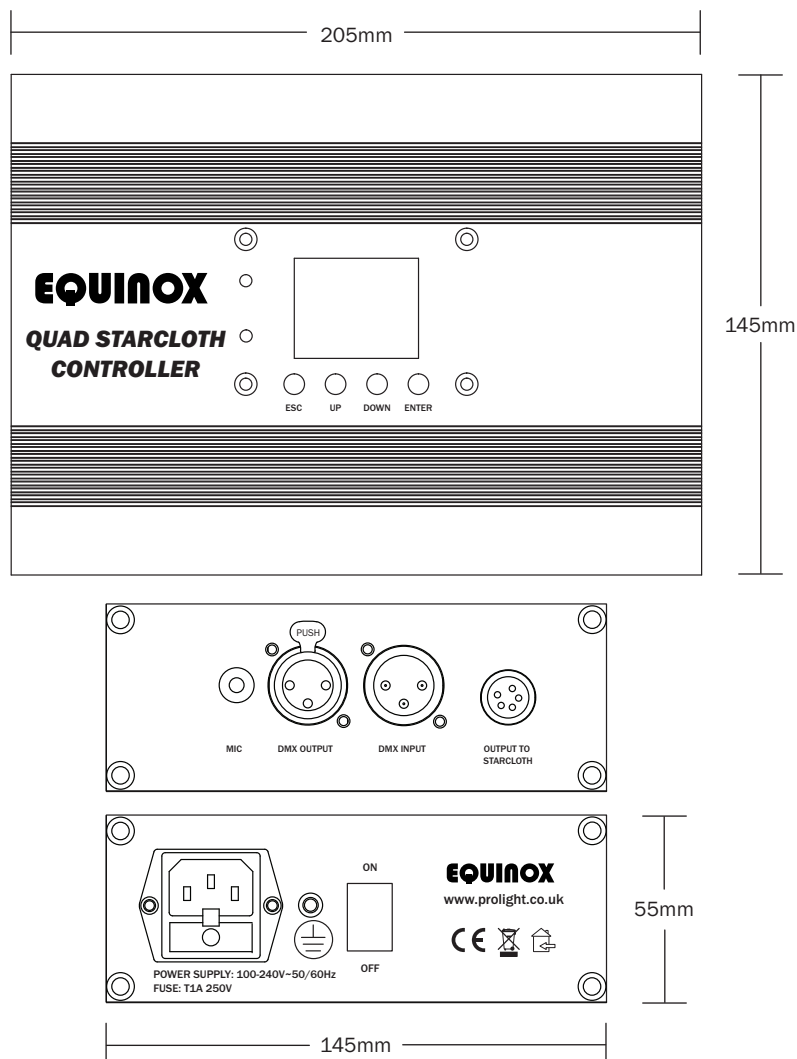

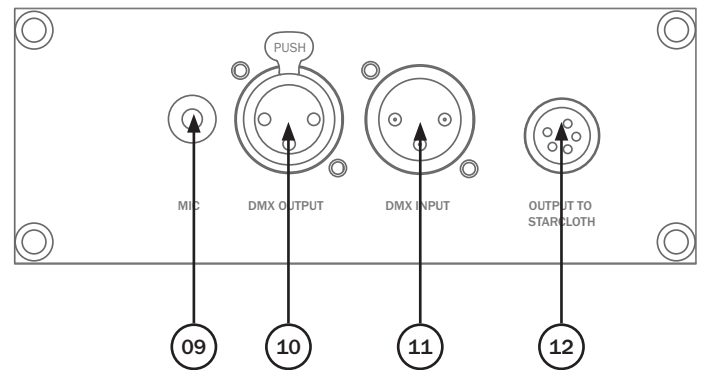
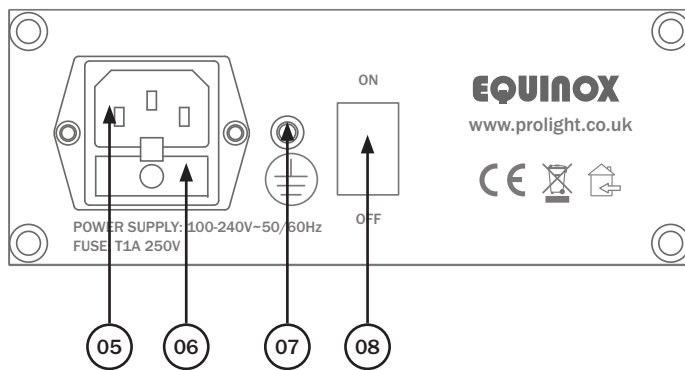
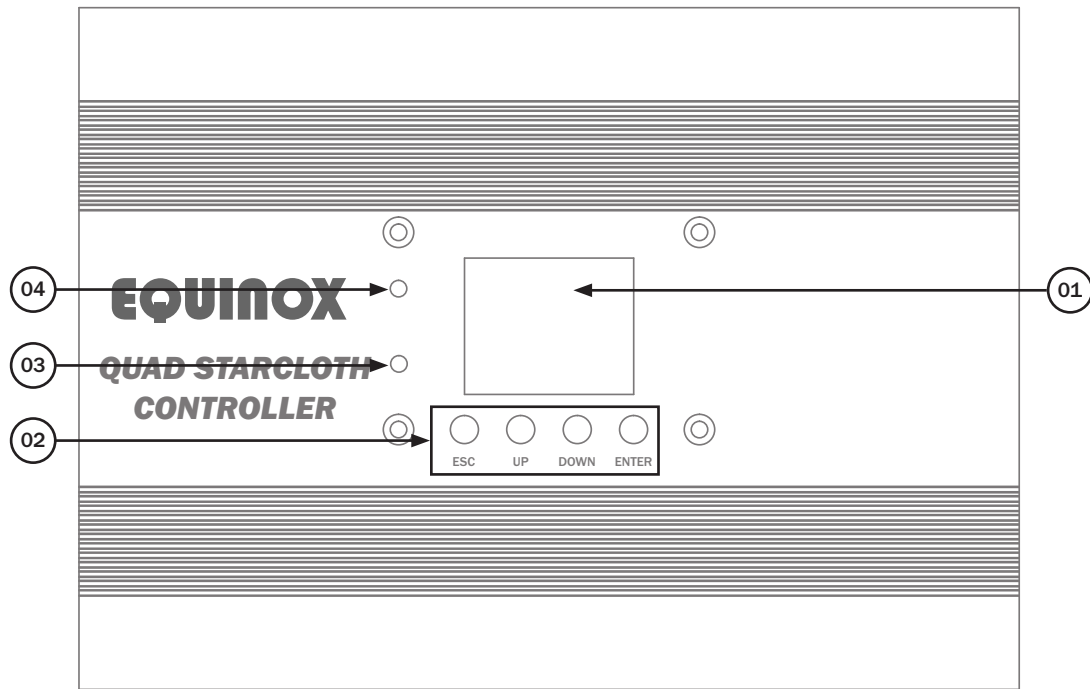

- 01 - LCD display
- 02 - Function buttons
- 03 - Signal indicator
- 04 - Power indicator

- 05 - Power in socket
- 06 - Fuse T1A 250V
- 07 - Earth point
- 08 - On/off switch

- 09 - Microphone
- 10 - 3-Pin DMX output
- 11 - 3-Pin DMX input
- 12 - Output to starcloth

In the box:
1 x starcloth,
1 x power cable,
1 x controller &
1 x user manual

Fitting instructions:

This cloth is designed to be fitted to the Equinox Truss Booth.

Fit the cloth from the top of the booth first by hanging the three sewn in top pockets onto the booth. Carefully insert the crossbars through the square holes in either side of the cloth and secure on the Truss Booth via the thumbscrews.

Once the crossbars have been fitted, the cloth must be tensioned along the bottom and sides by the integral velcro straps.

DMX mode:

To access the DMX mode, from the home menu press “**ENTER**” button and use the “**UP/DOWN**” buttons to highlight “**DMX**”. Now press the “**ENTER**” button and use the “**UP**” and “**DOWN**” buttons to choose between the following settings;

Channel Set: Press the “**ENTER**” button and use the “**UP**” and “**DOWN**” buttons to select between the 3/9 or 28 channel modes. Press the “**ESC**” button to confirm the setting.

DMX Fail: Press the “**ENTER**” button and use the “**UP**” and “**DOWN**” buttons to select between Auto, Hold, Blackout or Sound modes. Press the “**ESC**” button to confirm the setting.

Address Set: Press the “**ENTER**” button and use the “**UP**” and “**DOWN**” buttons to select the DMX address required between 001 and 512. Press the “**ESC**” button to confirm the setting.

Signal In: This function is to check whether the controller is receiving a DMX input.

To exit out of any of the above options, press the “**ESC**” button.

3 channel mode:

Channel	Value	Function
1	000-009	Blackout
	010-019	Red
	020-029	Green
	030-039	Blue
	040-049	White
	050-059	Yellow
	060-069	Purple
	070-079	Cyan
	080-089	Pink
	090-099	Dark Orange
	100-109	Light Yellow
	110-119	Light Purple
	120-129	Gold
	130-139	Light Green
	140-149	Light Pink
	150-159	Dark Purple
	160-169	Orange
	170-179	All On
	180-189	Red & White
	190-199	Pink & White
	200-209	Yellow & White
	210-219	Green & White
	220-229	Blue & White
	230-239	Red & Blue
	240-249	Pink & Red
250-255	Blue & Yellow	

Channel	Value	Function
2	000-009	Static pattern 1
	010-019	Static pattern 2
	020-029	Static pattern 3
	030-039	Static pattern 4
	040-049	Static pattern 5
	050-059	Static pattern 6
	060-119	Static pattern cycle (1-6)
	120-129	Multi colour pattern 1
	130-139	Multi colour pattern 2
	140-149	Multi colour pattern 3
	150-159	Multi colour pattern 4
	160-169	Multi colour pattern 5
	170-179	Multi colour pattern 6
	180-189	Multi colour pattern 7
190-199	Multi colour pattern 8	
3	200-209	Multi colour pattern 9
	210-219	Multi colour pattern 10
	220-229	Multi colour pattern 11
	230-255	Multi colour pattern cycle (1-11)
	000-009	Stop (static pattern)
3	010-200	Slow to fast (static pattern)
	000-200	Slow to fast (multi colour pattern)
	201-255	Sound active

9 channel mode:

Channel	Value	Function
1	000-006	Blackout
	007-013	Red
	014-020	Green
	021-027	Blue
	028-034	White
	035-041	Yellow
	042-048	Purple
	049-055	Cyan
	056-062	Pink
	063-069	Dark Orange
	070-076	Light Yellow
	077-083	Light Purple
	084-090	Gold
	091-097	Light Green
	098-104	Light Pink
	105-111	Dark Purple
	112-118	Orange
	119-125	All On
	126-132	Red & White
	133-139	Pink & White
	140-146	Yellow & White
	147-153	Green & White
	154-160	Blue & White
	161-167	Red & Blue
	168-174	Pattern 1
	175-181	Pattern 2
	182-188	Pattern 3
	189-195	Pattern 4
	196-202	Pattern 5
	203-209	Pattern 6
	210-216	Pattern 7
	217-223	Pattern 8
	224-230	Pattern 9
231-237	Pattern 10	
238-244	Pattern 11	
245-251	Pattern cycle (1-11)	
252-255	Pattern cycle (1-11) via sound active	

Cont...

9 channel mode cont...:

Channel	Value	Function
2	000-009	Stop (static and multi-colour patterns, CH1 between 000-167)
	010-255	Slow-fast (static and multi-colour patterns, CH1 between 000-167)
3	000-255	Slow-fast (auto patterns, CH1 between 168-251)
4	000-255	Red 0-100% (CH1 between 000-006)
5	000-255	Green 0-100% (CH1 between 000-006)
6	000-255	Blue 0-100% (CH1 between 000-006)
7	000-255	White 0-100% (CH1 between 000-006)
8	000-034	Static pattern 1 (CH1 between 007-167)
	035-069	Static pattern 2 (CH1 between 007-167)
	070-104	Static pattern 3 (CH1 between 007-167)
	105-139	Static pattern 4 (CH1 between 007-167)
	140-174	Static pattern 5 (CH1 between 007-167)
	175-209	Static pattern 6 (CH1 between 007-167)
	210-255	Static pattern cycle (1-6) (CH1 between 010-129)
9	000-029	Multi colour pattern 1
	030-059	Multi colour pattern 2
	060-089	Multi colour pattern 3
	090-119	Multi colour pattern 4
	120-149	Multi colour pattern 5
	150-179	Multi colour pattern 6
	180-209	Multi colour pattern 7
	210-239	Multi colour pattern 8
	240-255	Multi colour pattern cycle (1-8)

28 channel mode:

Channel	Value	Function
1	000-009	Blackout
	010-019	Red
	020-029	Green
	030-039	Blue
	040-049	White
	050-059	Yellow
	060-069	Purple
	070-079	Cyan
	080-089	Pink
	090-099	Dark Orange
	100-109	Light Yellow
	110-119	Warm White
	120-129	All On
	130-139	Pattern 1
	140-149	Pattern 2
	150-159	Pattern 3
	160-169	Pattern 4
	170-179	Pattern 5
	180-189	Pattern 6
	190-199	Pattern 7
	200-209	Pattern 8
	210-219	Pattern 9
	220-229	Pattern 10
	230-239	Pattern 11
	240-249	Pattern cycle (1-11)
250-255	Pattern cycle (1-11) via sound active	
2	000-009	Stop (static and multi-colour patterns, CH1 between 000-119)
	010-255	Slow-fast (static and multi-colour patterns, CH1 between 000-119)
3	000-255	Slow-fast (auto patterns, CH1 between 120-219)
4	000-024	Static pattern 1 (CH1 between 010-139)
	025-049	Static pattern 2 (CH1 between 010-139)
	050-074	Static pattern 3 (CH1 between 010-139)
	075-099	Static pattern 4 (CH1 between 010-139)
	100-124	Static pattern 5 (CH1 between 010-139)
	125-149	Static pattern 6 (CH1 between 010-139)
	150-174	Static pattern 7 (CH1 between 010-139)
	175-199	Static pattern 8 (CH1 between 010-139)
	200-224	Static pattern 9 (CH1 between 010-139)
	225-255	Static pattern cycle (1-9) (CH1 between 010-139)

Cont...

28 channel mode cont...:

Channel	Value	Function
5	000-255	Red 1 0-100% (CH1 between 000-009)
6	000-255	Green 1 0-100% (CH1 between 000-009)
7	000-255	Blue 1 0-100% (CH1 between 000-009)
8	000-255	White 1 0-100% (CH1 between 000-009)
9	000-255	Red 2 0-100% (CH1 between 000-009)
10	000-255	Green 2 0-100% (CH1 between 000-009)
11	000-255	Blue 2 0-100% (CH1 between 000-009)
12	000-255	White 2 0-100% (CH1 between 000-009)
13	000-255	Red 3 0-100% (CH1 between 000-009)
14	000-255	Green 3 0-100% (CH1 between 000-009)
15	000-255	Blue 3 0-100% (CH1 between 000-009)
16	000-255	White 3 0-100% (CH1 between 000-009)
17	000-255	Red 4 0-100% (CH1 between 000-009)
18	000-255	Green 4 0-100% (CH1 between 000-009)
19	000-255	Blue 4 0-100% (CH1 between 000-009)
20	000-255	White 4 0-100% (CH1 between 000-009)
21	000-255	Red 5 0-100% (CH1 between 000-009)
22	000-255	Green 5 0-100% (CH1 between 000-009)
23	000-255	Blue 5 0-100% (CH1 between 000-009)
24	000-255	White 5 0-100% (CH1 between 000-009)
25	000-255	Red 6 0-100% (CH1 between 000-009)
26	000-255	Green 6 0-100% (CH1 between 000-009)
27	000-255	Blue 6 0-100% (CH1 between 000-009)
28	000-255	White 6 0-100% (CH1 between 000-009)

Auto mode:

To access the Auto mode, from the home menu press “ENTER” button and use the “UP/DOWN” buttons to highlight “Auto”. Now press the “ENTER” button and use the “UP” and “DOWN” buttons to select between “Program01” to “Program12”. Press the “ENTER” button and use the “UP” and “DOWN” buttons to select the speed between “Speed: 00” to “Speed: 99”.

Press the “ESC” button to confirm the setting.

To exit out of any of the above options, press the “ESC” button.

Sound mode:

To access the Sound mode, from the home menu press “ENTER” button and use the “UP/DOWN” buttons to highlight “Sound”. Now press the “ENTER” button and use the “UP” and “DOWN” buttons to choose between the following settings;

Sound Program: Press the “ENTER” button and use the “UP” and “DOWN” buttons to select between “Sound Program :01” to “Sound Program :12”. Press the “ESC” button to confirm the setting.

Sound Sensitivity: Press the “ENTER” button and use the “UP” and “DOWN” buttons to select the sound sensitivity between “Sensitivity :00” to “Sensitivity :31”. Press the “ESC” button to confirm the setting.

To exit out of any of the above options, press the “ESC” button.

Static colour mode:

To access the Static colour mode, from the home menu press “ENTER” button and use the “UP/DOWN” buttons to highlight “Static”. Now press the “ENTER” button and use the “UP” and “DOWN” buttons to select the colour required between “C01” to “C30”. Press the “ENTER” button and use the “UP” and “DOWN” buttons to select the program for the colour between “Program:01” to “Program:07”. Press the “ENTER” button and use the “UP” and “DOWN” buttons to select the speed of the program between “SP:00” to “SP:99”. Press the “ESC” button to confirm the setting.

To exit out of any of the above options, press the “ESC” button.

Colour mix mode:

To access the Colour mix mode, from the home menu press “ENTER” button and use the “UP/DOWN” buttons to highlight “Mix”. Now press the “ENTER” button and use the “UP” and “DOWN” buttons to select the colour required “Red”, “Green”, “Blue” or “White”. Press the “ENTER” button and use the “UP” and “DOWN” buttons to select the brightness for the colour between “000” to “255”. Press the “ESC” button and use the “UP” and “DOWN” buttons to select “Program” to select the program for the colour between “Program : 01” to “Program : 09”. Press the “ESC” button and use the “UP” and “DOWN” buttons to select “Program Speed” to select the program speed between “Program Speed : 00” to “Program Speed : 99”. Press the “ESC” button to confirm the setting.

To exit out of any of the above options, press the “ESC” button.

Factory reset:

To perform a factory reset, from the home menu press “**ENTER**” button and use the “**UP/DOWN**” buttons to highlight “**Set**”. Now press the “**ENTER**” button and use the “**UP**” and “**DOWN**” buttons to select “**Factory reset**”. Press the “**ENTER**” button and use the “**UP**” and “**DOWN**” buttons to select “**Yes**”. Press the “**ENTER**” button, a confirmation message will appear. Use the “**UP**” and “**DOWN**” buttons to select “**Yes**”. Press the “**ENTER**” button, the controller will now perform a factory reset.

Setting the DMX address:

The DMX mode enables the use of a universal DMX controller. Each fixture requires a “start address” from 1- 512. A fixture requiring one or more channels for control begins to read the data on the channel indicated by the start address. For example, a fixture that occupies or uses 7 channels of DMX and was addressed to start on DMX channel 100, would read data from channels: 100,101,102,103,104,105 and 106. Choose a start address so that the channels used do not overlap. E.g. the next unit in the chain starts at 107.

DMX 512:

DMX (Digital Multiplex) is a universal protocol used as a form of communication between intelligent fixtures and controllers. A DMX controller sends DMX data instructions from the controller to the fixture. DMX data is sent as serial data that travels from fixture to fixture via the DATA “IN” and DATA “OUT” XLR terminals located on all DMX fixtures (most controllers only have a data “out” terminal).

DMX linking:

DMX is a language allowing all makes and models of different manufactures to be linked together and operate from a single controller, as long as all fixtures and the controller are DMX compliant. To ensure proper DMX data transmission, when using several DMX fixtures try to use the shortest cable path possible. The order in which fixtures are connected in a DMX line does not influence the DMX addressing. For example; a fixture assigned to a DMX address of 1 may be placed anywhere in a DMX line, at the beginning, at the end, or anywhere in the middle. When a fixture is assigned a DMX address of 1, the DMX controller knows to send DATA assigned to address 1 to that unit, no matter where it is located in the DMX chain.

DATA cable (DMX cable) requirements (for DMX operation):

This fixture can be controlled via DMX-512 protocol. The DMX address is set on the back of the unit. Your unit and your DMX controller require a standard 3-pin XLR connector for data input/output, see image below.



Further DMX cables can be purchased from all good sound and lighting suppliers or Pro Light Concepts dealers.

Please quote:

CABL10 – 2m

CABL11 – 5m

CABL12 – 10m

Also remember that DMX cable must be daisy chained and cannot be split.

Notice:

Be sure to follow the diagrams below when making your own cables. Do not connect the cables shield conductor to the ground lug or allow the shield conductor to come in contact with the XLRs outer casing. Grounding the shield could cause a short circuit and erratic behaviour.

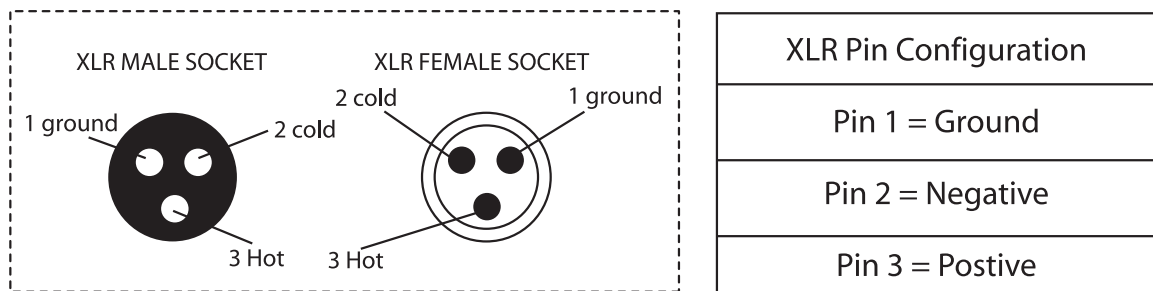
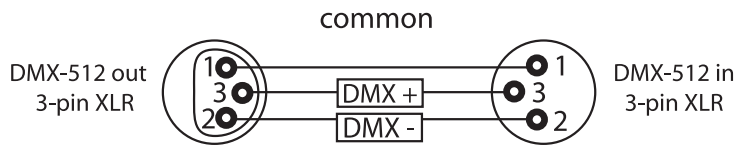

Special note:

Line termination:

When longer runs of cable are used, you may need to use a terminator on the last unit to avoid erratic behaviour.

Using a cable terminator will decrease the possibilities of erratic behaviour.

(3-pin - Order ref: CABL90, 5-pin - Order ref: CABL89)

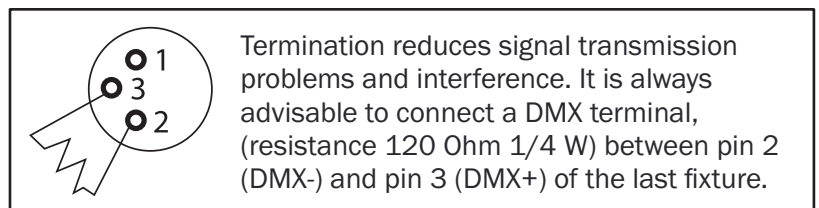

5-pin XLR DMX connectors:

Some manufactures use 5-pin XLR connectors for data transmission in place of 3-pin. 5-pin XLR fixtures may be implemented in a 3-pin XLR DMX line. When inserting standard 5-pin XLR connectors in to a 3-pin line a cable adaptor must be used. The diagram below details the correct cable conversion.

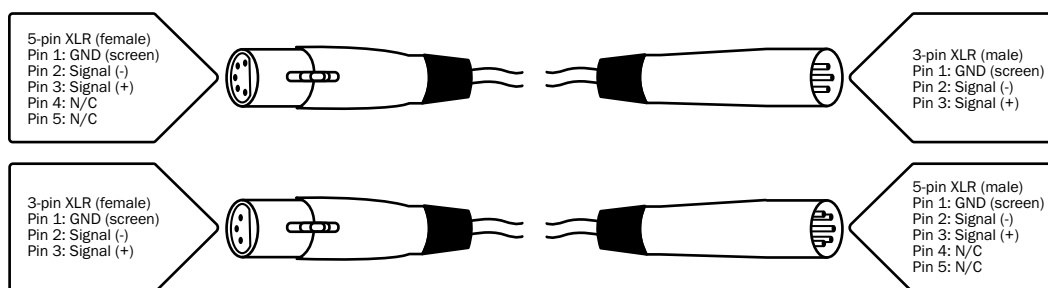



Correct Disposal of this Product (Waste Electrical & Electronic Equipment)

**(Applicable in the European Union and other European countries
with separate collection systems)**

This marking shown on the product or its literature, indicates that it should not be disposed of with other household wastes at the end of its working life. To prevent possible harm to the environment or human health from uncontrolled waste disposal, please separate this from other types of wastes and recycle it responsibly to promote the sustainable reuse of material resources.

Household users should contact either the retailer where they purchased this product, or their local government office, for details of where and how they can take this item for environmentally safe recycling.

Business users should contact their supplier and check the terms and conditions of the purchase contract. This product should not be mixed with other commercial wastes for disposal.



Please contact your local retailer to purchase these accessories.



Truss Booth Cool White
LED Starcloth System
Order code: EQLED150B

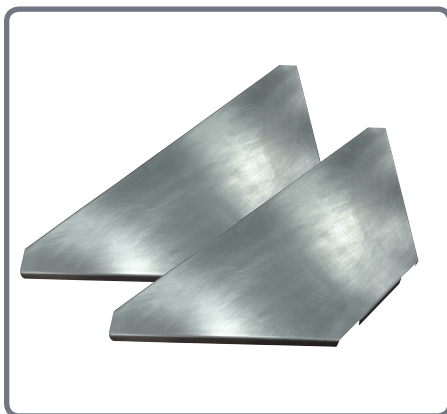

Truss Booth Shelf Kit (Pair)
Order code: EQLED150H

EQUINOX