

BT-GIGAFLASH

RGB

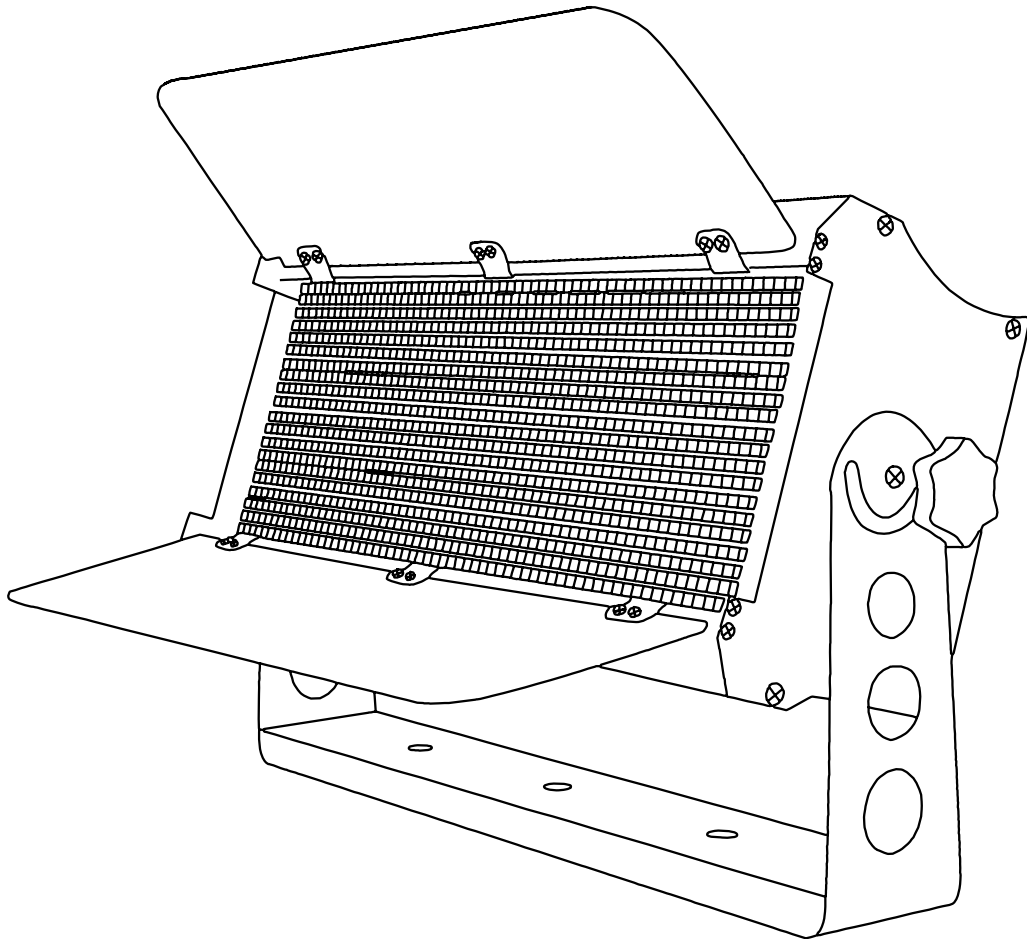

ENGLISH

Operation Manual

Other languages can be downloaded from:
WWW.BRITEQ-LIGHTING.COM



Version: 1.0



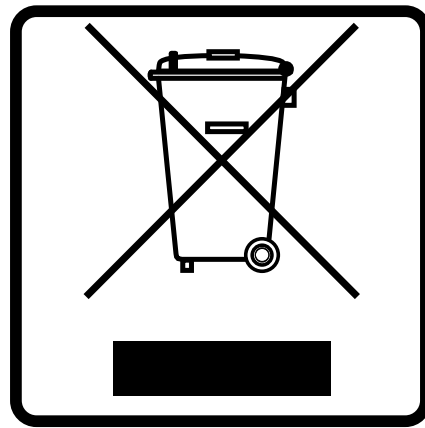

EN - DISPOSAL OF THE DEVICE

Dispose of the unit and used batteries in an environment friendly manner according to your country regulations.

FR - DÉCLASSER L'APPAREIL

Débarrassez-vous de l'appareil et des piles usagées de manière écologique Conformément aux dispositions légales de votre pays.

NL - VERWIJDEREN VAN HET APPARAAT

Verwijder het toestel en de gebruikte batterijen op een milieuvriendelijke manier conform de in uw land geldende voorschriften.

DU - ENTSORGUNG DES GERÄTS

Entsorgen Sie das Gerät und die Batterien auf umweltfreundliche Art und Weise gemäß den Vorschriften Ihres Landes.

ES - DESHACERSE DEL APARATO

Reciclar el aparato y pilas usadas de forma ecologica conforme a las disposiciones legales de su país.

PT - COMO DESFAZER-SE DA UNIDADE

Tente reciclar a unidade e as pilhas usadas respeitando o ambiente e em conformidade com as normas vigentes no seu país.

OPERATION MANUAL

Thank you for buying this Briteq® product. To take full advantage of all possibilities and for your own safety, please read these operating instructions very carefully before you start using this unit.

FEATURES

- Extremely powerful RGB LED strobe with 3 separately controllable segments!
- 1260 RGB strobe LEDs for an exceptional light output
- **Long time blinder function** with auto fade down function
- Stunning built-in **random pixel strobe effects**, no extra programming needed.
- Full DMX-control with:
 - 7 different channel modes for strobe effects (1ch to 13ch)
 - 3 different pixel control modes (1ch to 9ch)
- LCD-display for easy setup menu navigation
- The 2-leaf barndoor with glossy internal reflector increases the visual output and protects during transport.
- Can be used as wash projector at reduced output (*ex. light up the stage during technical buildup of a gig*)
- TV-Studio ready:
 - Flicker free 2 kHz LED refresh rate
 - Low noise cooling system
- Compact and sturdy ALU-housing with tempered glass in front of the leds, perfect for rental companies!
- Strong hanging bracket, prepared for use with omega clamps for fast installation.
- In case of DMX failure you can choose between blackout and freeze mode.
- Lock function to avoid unwanted altering of the settings.
- Default factory settings can be loaded.
- 3pin & 5pin XLR along with power in/outputs for easy daisy chaining of several units up to 16A.
- Power supply with active PFC.

BEFORE USE

- Before you start using this unit, please check if there's no transportation damage. Should there be any, do not use the device and consult your dealer first.
- **Important:** This device left our factory in perfect condition and well packaged. It is absolutely necessary for the user to strictly follow the safety instructions and warnings in this user manual. Any damage caused by mishandling is not subject to warranty. The dealer will not accept responsibility for any resulting defects or problems caused by disregarding this user manual.
- Keep this booklet in a safe place for future consultation. If you sell the fixture, be sure to add this user manual.

Check the contents:

Check that the carton contains the following items:

- English operating instructions, other languages can be downloaded from our website.
- BT-GIGAFLASH RGB
- Mains powercable

SAFETY INSTRUCTIONS:



CAUTION
RISK OF ELECTRIC SHOCK
DO NOT OPEN



CAUTION: To reduce the risk of electric shock, do not remove the top cover. No user-serviceable parts inside. Refer servicing to qualified service personnel only.



The lightning flash with arrowhead symbol within the equilateral triangle is intended to alert the user or the presence of un-insulated "dangerous voltage" within the product's enclosure that may be of sufficient magnitude to constitute a risk of electric shock.



The exclamation point within the equilateral triangle is intended to alert the user to the presence of important operation and maintenance (servicing) instructions in the literature accompanying this appliance.



This symbol means: indoor use only



This symbol means: Read instructions



This symbol determines: the minimum distance from lighted objects. The minimum distance between light-output and the illuminated surface must be more than 1 meters

RISK GROUP 2
CAUTION:
Do not stare at operating lamp

CAUTION: Do not stare at operating lamp.
May be harmful to the eyes.

- To protect the environment, please try to recycle the packing material as much as possible.
- To prevent fire or shock hazard, do not expose this appliance to rain or moisture.
- To avoid condensation to be formed inside, allow the unit to adapt to the surrounding temperatures when bringing it into a warm room after transport. Condense sometimes prevents the unit from working at full performance or may even cause damages.
- This unit is for indoor use only.
- Don't place metal objects or spill liquid inside the unit. Electric shock or malfunction may result. If a foreign object enters the unit, immediately disconnect the mains power.
- Locate the fixture in a well ventilated spot, away from any flammable materials and/or liquids. The fixture must be fixed at least 50cm from surrounding walls.
- Don't cover any ventilation openings as this may result in overheating.
- Prevent use in dusty environments and clean the unit regularly.
- Keep the unit away from children.
- Inexperienced persons should not operate this device.
- Maximum safe ambient temperature is 40°C. Don't use this unit at higher ambient temperatures.
- Make sure the area below the installation place is free from unwanted persons during rigging, de-rigging and servicing.
- Allow the device about 10 minutes to cool down before to start servicing.
- Always unplug the unit when it is not used for a longer time or before to start servicing.
- The electrical installation should be carried out by qualified personal only, according to the regulations for electrical and mechanical safety in your country.
- Check that the available voltage is not higher than the one stated on the unit.
- The power cord should always be in perfect condition. Switch the unit immediately off when the power cord is squashed or damaged. It must be replaced by the manufacturer, its service agent or similarly qualified persons in order to avoid a hazard.
- Never let the power-cord come into contact with other cables!
- This fixture must be earthed in order to comply with safety regulations.
- Don't connect the unit to any dimmer pack.
- Always use an appropriate and certified safety cable when installing the unit.
- In order to prevent electric shock, do not open the cover. Apart from the mains fuse there are no user serviceable parts inside.
- **Never** repair a fuse or bypass the fuse holder. **Always** replace a damaged fuse with a fuse of the same type and electrical specifications!
- In the event of serious operating problems, stop using the fixture and contact your dealer immediately.
- The housing and the lenses must be replaced if they are visibly damaged.
- Please use the original packing when the device is to be transported.
- Due to safety reasons it is prohibited to make unauthorized modifications to the unit.

Important: Never look directly into the light source! Don't use the effect in the presence of persons suffering from epilepsy.

DESCRIPTION:

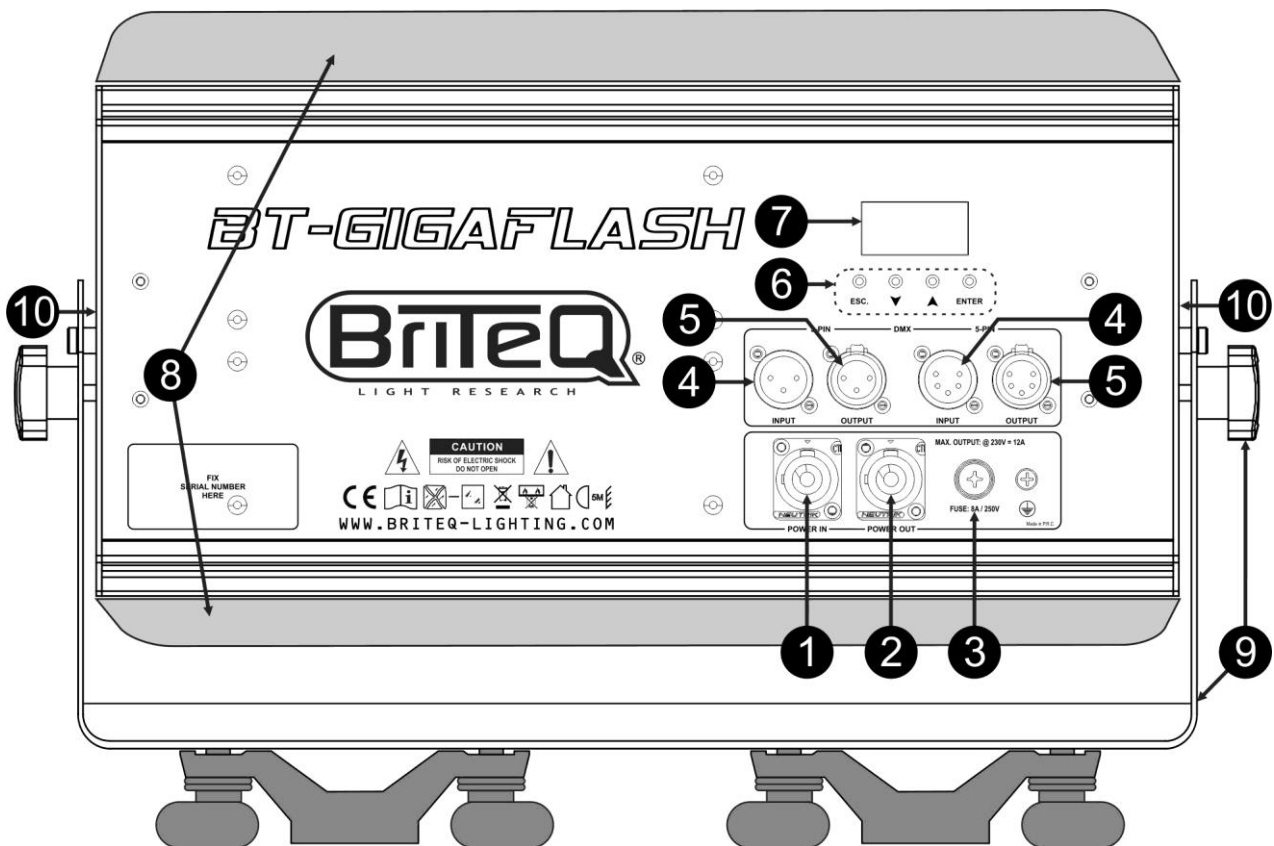

1. **MAINS INPUT:** Connect the supplied mains cable or any PowerCon® extension cable here.
2. **MAINS OUTPUT:** used to daisy chain the power to several other projectors. Always pay attention to the maximum load while adding projectors! Special Multi cables (PowerCON® + DMX XLR-cables are optionally available: see our website!)
3. **MAINS FUSE:** protects the unit in case of electrical problems, always use the prescribed fuse!
4. **DMX IN:** both 3pin and 5pin inputs are available to daisy chain the projector with other units that will be controlled by a DMX-controller. The DMX-inputs are also used to update the firmware of the projector, see the upgrade instructions on our website.
5. **DMX OUT:** both 3pin and 5pin outputs are available to daisy chain the projector with other units that will be controlled by a DMX-controller.
6. **[MENU] buttons:** used to browse the different options of the setup menu.
 - **ESC. Button:** press shortly to go 1 level up & press several times until the standard display is shown.
 - **▲/▼ Buttons:** used to browse the menu items and change the values of the selected function.
 - **[ENTER]-button:** used to confirm the current action.
7. **DISPLAY:** the backlit LCD-display shows important information like: channel mode, DMX-start/end address, ... The backlight is lit as soon as one of the buttons is pressed. A capital [S] blinks in the upper right corner when a DMX-signal is detected.
8. **2-LEAF BARNDOOR:** with glossy internal reflector to increase the visual output and protect the front glass during transport. Put the leaves in the right position to increase the output drastically or block the strobe light in certain directions.
9. **BRACKET:** multifunctional and very stable design for both floor and truss mounting. Prepared to install omega brackets, optionally available from Briteq. The projector can be directed in any direction.
10. **COOLING FAN:** during its operation the projector produces heat that must be dissipated. The fan inside the projector must be able to evacuate the heat in the most effective way. Therefore is it very important not to cover any of the ventilation openings as this may result in overheating.

OVERHEAD RIGGING

Important: The installation must be carried out by qualified service personal only. Improper installation can result in serious injuries and/or damage to property. Overhead rigging requires extensive experience! Working load limits should be respected, certified installation materials should be used, the installed device should be inspected regularly for safety.

- Make sure the area below the installation place is free from unwanted persons during rigging, de-rigging and servicing.
- Locate the fixture in a well ventilated spot, far away from any flammable materials and/or liquids. The fixture must be fixed **at least 50cm** from surrounding walls.
- The device should be installed out of reach of people and outside areas where persons may walk by or be seated.
- Before rigging make sure that the installation area can hold a minimum point load of 10times the device's weight.
- Always use a certified safety cable that can hold 12times the weight of the device when installing the unit. This secondary safety attachment should be installed in a way that no part of the installation can drop more than 20cm if the main attachment fails.

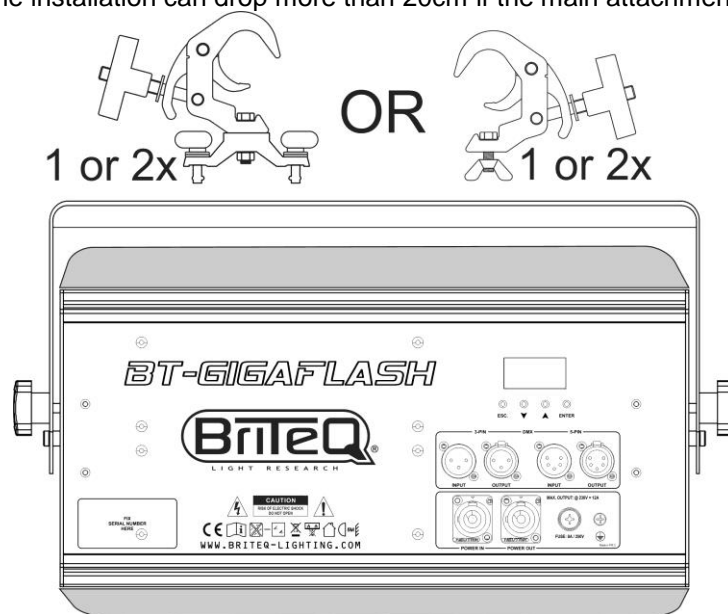

- The device should be well fixed; a free-swinging mounting is dangerous and may not be considered!
- Don't cover any ventilation openings as this may result in overheating.
- The operator has to make sure that the safety-relating and machine-technical installations are approved by an expert before using them for the first time. The installations should be inspected every year by a skilled person to be sure that safety is still optimal.

SETUP MENU

With the setup menu you can fully configure the projector. All settings are preserved when the unit is disconnected from the mains.

General instructions for setup.

The SETUP-menu has two logically structured levels, see the menu structure on the previous page.

- Press the ▲/▼ buttons to browse the different functions of the setup menu until the required function is shown on the display.
- Press the [ENTER] button to access the function and change its parameters.
- Use ▲/▼ buttons to change the value.
- Press the [ENTER] button again confirm.
- To jump to a higher menu level: press the [ESC.] button.
- To exit the SETUP-menu: press the [ESC.] button several times until the standard display is shown.

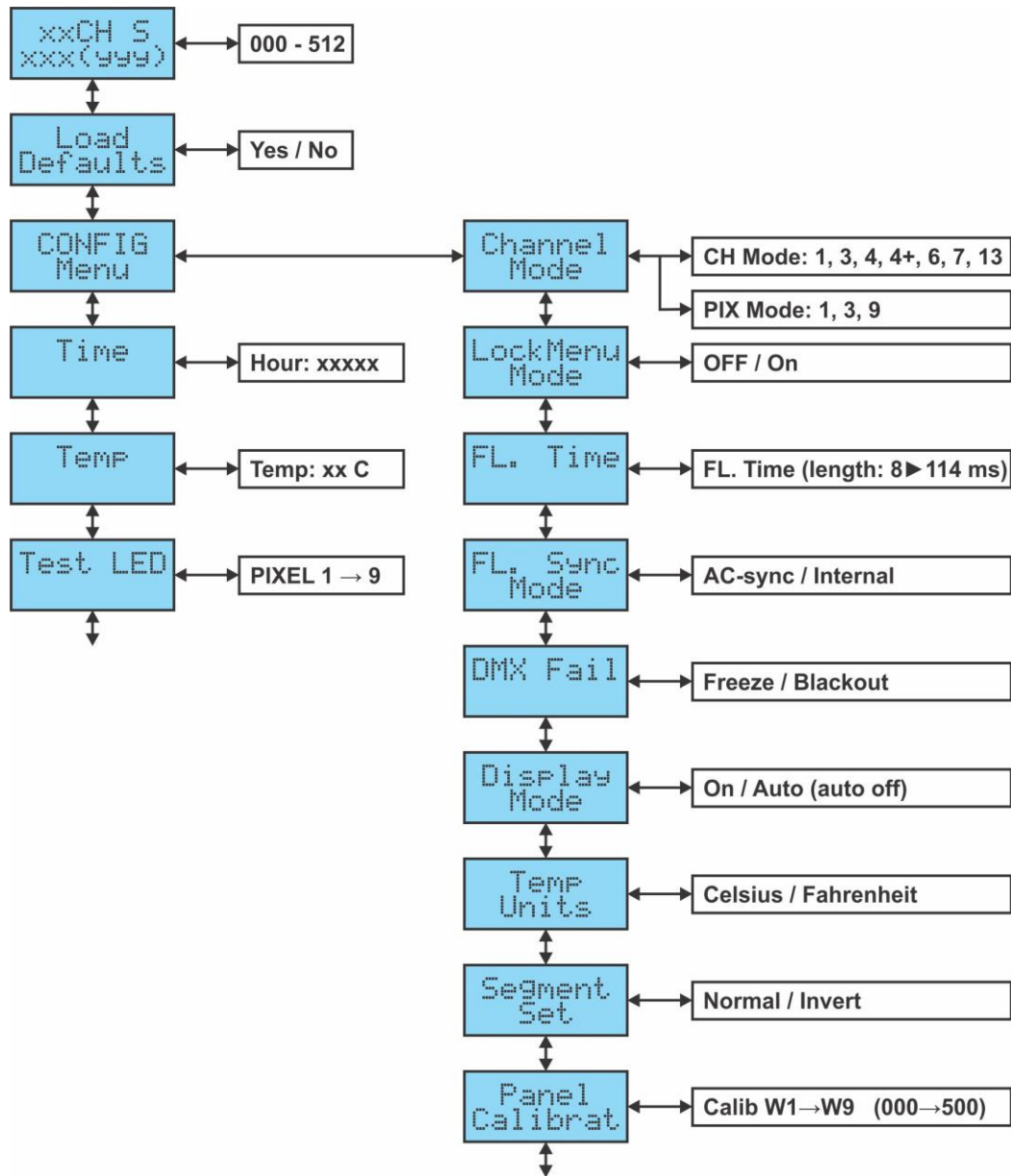

Change the DMX-address > [DMX Addr] –

The standard display shows the selected DMX-mode and the DMX start + end address.

- Press the [ENTER] button: to change the values of the DMX-start address.
- Use ▲/▼ buttons to select the desired DMX512 address. The last occupied DMX-address is also shown: makes it easier to set the address of the next unit in the chain.
- Once the correct address shows on the display, press the [ENTER] button to confirm.
- Press the [ESC.] button to return to the standard display.

[LOAD DEFAULTS] –

This is your emergency exit if you really messed up the settings: just return to FACTORY preset.

- Press the ▲/▼ buttons until the function is showing on the display.
- Press the [ENTER] button to select, display shows [LOAD?]
- Use ▲/▼ buttons to select [YES] or [NO]
- Press [ENTER] to confirm.

Enter the [CONFIG Menu] –

In this menu you can adapt the different parameters.

- Press the ▲/▼ buttons until [CONFIG Menu] is showing on the display.
- Press the [ENTER] button to enter the configuration menu.
- Press the ▲/▼ buttons until the desired function is showing on the display.

- Press the [ENTER] button: the values can be changed
These are the functions to choose from:

[CONFIG Menu > Channel Mode] –

Used to set the desired channel mode.

- Once this function is shown on the display: press the [ENTER] button: the values can be changed.
- Use ▲/▼ buttons to select the desired mode, there are two kinds of Channel modes:
 - **Normal [CH Mode]:** different ways to control the different strobe functions.
 - **Special [PIX Mode]:** different ways to control the dimmer of the different sections (pixel control).
See the different DMX-charts in this user manual to make your choice.
- Once the correct option shows on the display, press the [ENTER] button to select.

[CONFIG Menu > LockMenu Mode] –

Used to lock the setup menu against unwanted altering of the settings.

- Once this function is shown on the display, press the [ENTER] button to select.
- Use ▲/▼ buttons to select:
 - **[OFF]:** The setup menu can be used at any time.
 - **[ON]:** After a short time the setup menu locks automatically, the display shows “**Locked**”.
Unlock the display by pressing the buttons in this order: ▲, ▼, ▲, ▼, [ENTER].
- Press the [ESC.] button to confirm and return to the menu.

[CONFIG Menu > FL. Time]

Used to set the flash length.

- Once this function is shown on the display, press the [ENTER] button to select.
- Use ▲/▼ buttons to adapt the length of the flashes between 8ms (short) and 114ms (long).
- Press the [ESC.] button to confirm and return to the menu.

Note: the default value = 14ms..

[CONFIG Menu > FL. Sync Mode]

Used to set how the strobe fill be synchronized over several units.

- Once this function is shown on the display, press the [ENTER] button to select.
- Use ▲/▼ buttons to select:
 - **[AC-sync]:** flash synchronization is done on the AC-input.
 - **[Internal]:** flash synchronization is done on the internal clock. (default)
- Press the [ESC.] button to confirm and return to the menu.

[CONFIG Menu > DMX Fail] –

Used to set how the projector reacts when the DMX-signal disappears.

- Once this function is shown on the display, press the [ENTER] button to select.
- Use ▲/▼ buttons to select:
 - **[Blackout]:** output turns black while no DMX is detected.
 - **[Freeze]:** output based on the last valid DMX-signal is kept on the projector.
- Press the [ESC.] button to confirm and return to the menu.

Note: as soon as the input detects a DMX-signal, blackout or freeze mode will be cancelled.

[CONFIG Menu > Display Mode] –

Used to choose if the display turns dark automatically or not.

- Once this function is shown on the display, press the [ENTER] button to select.
- Use ▲/▼ buttons to select:
 - **[On]:** Backlight is always on.
 - **[Auto]:** Backlight turns off automatically.
- Press the [ESC.] button to confirm and return to the menu.

[CONFIG Menu > Temp Units] –

Used to select if the LED-temperature is shown in degrees Celcius [°C] or Fahrenheit [°F].

- Once this function is shown on the display, press the [ENTER] button to select.
- Use ▲/▼ buttons to select:

- **[Celsius]:** LED-temperature is shown in degrees Celsius [°C].
- **[Fahrenheit]:** LED-temperature is shown in degrees Fahrenheit [°F].
- Press the [ESC.] button to confirm and return to the menu.

[CONFIG Menu > Segment Set] –

Used to invert the numbering of the segments.

- Once this function is shown on the display, press the [ENTER] button to select.
- Use ▲/▼ buttons to select:
 - **Normal:** Segments numbered from left to right while standing in front of the strobe.
 - **Invert:** Segments numbered from right to left while standing in front of the strobe.
- Press the [ESC.] button to confirm and return to the menu.

[CONFIG Menu > Panel Calibrat] –

Used to calibrate the light output of the different sections.

- Once this function is shown on the display, press the [ENTER] button: the display shows [Calib W1]
- Use ▲/▼ buttons to select the desired section to calibrate: [Calib W1] to ... [Calib W9]
- Press [ENTER] to adjust the brightness of the selected section (W1 ... W9):
All sections W1 to W9 light up.
 - Use ▲/▼ buttons to adjust the brightness of the selected section: the calibration is perfect once you cannot see a difference in output between the different sections.
- Press the [ESC.] button to confirm and return to the menu.

Remark: the differences between sections are very minimal and preset in the factory so don't worry if you don't see a big difference while calibrating.

[Time] –

Shows how many hours the unit was used since its 1st use.

- Press the ▲/▼ buttons until the function is showing on the display.
- Press the [ENTER] button to select, display shows the number of used hours.
- Press the [ESC.] button to return to the menu.

[Temp] –

Shows the actual temperature of the LEDs.

- Press the ▲/▼ buttons until the function is showing on the display.
- Press the [ENTER] button to select, display shows the actual temperature.
- Press the [ESC.] button to return to the menu.

[Test LED] –

Used to easily check if all leds are still working: perfect for rental business!

- Once this function is shown on the display, press the [ENTER] button: the display shows [ALL ON]
All LEDs are switched on at a very low output so you can easily check if they are all working without damaging your eyes.
- Use ▲/▼ buttons to select the separate segments one by one: [PIXEL1] to [PIXEL3]
- Press the [ESC.] button to confirm and return to the menu.

ELECTRICAL INSTALLATION



Important: The electrical installation should be carried out by qualified personal only, according to the regulations for electrical and mechanical safety in your country.

ELECTRICAL INSTALLATION FOR TWO OR MORE UNITS IN DMX-MODE:

Use this function when you want to control the projectors by any DMX controller.

- Connect the projectors as shown in the drawing below.

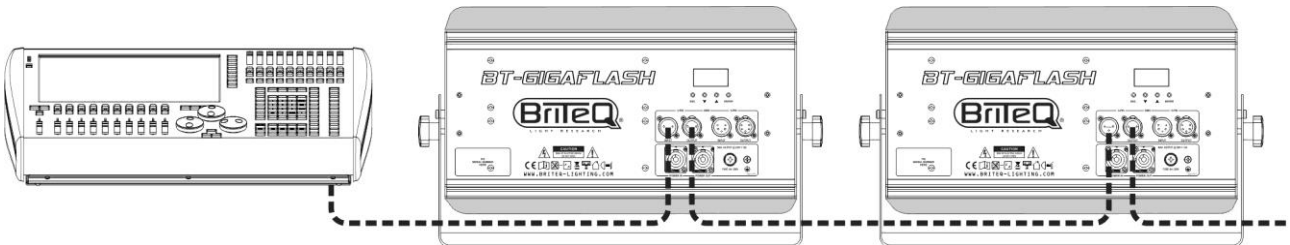

- First put the projectors in the desired DMX-mode: see the different DMX-charts and choose the one that suits you best.
- Give all projectors a start address: each projector shows its start + end address, make sure that the addresses do not overlap!

Some general information on DMX:

- The DMX-protocol is a widely used high speed signal to control intelligent light equipment. You need to "daisy chain" your DMX controller and all the connected units with a good quality balanced DMX-cable. Both XLR-3pin and XLR-5pin connectors are used, however XLR-3pin is more popular.
- Pin layout XLR-3pin: Pin1 = GND ~ Pin2 = Negative signal (-) ~ Pin3 = Positive signal (+)
- Pin layout XLR-5pin: Pin1 = GND ~ Pin2 = Negative signal (-) ~ Pin3 = Positive signal (+) ~ Pins4+5 not used.
- To prevent strange behavior of the light effects, due to interferences, you must use a 90Ω to 120Ω terminator at the end of the chain. Never use Y-splitter cables, this simply won't work!
- Make sure that all units are connected to the mains.
- Each light effect in the chain needs to have its proper starting address so it knows which commands from the controller it has to decode.

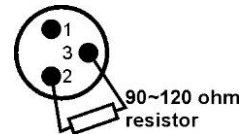

DMX CHARTS

Different DMX channels modes are available:

1CH MODE (WHITE COLOR)

Ch.	Value	Funtions
1	248-255	BLINDER effect
	006-247	Strobe rate (0-30Hz)
	000-005	Blackout (no output)

3CH MODE (WHITE COLOR)

Ch.	Value	Funtions
1	006-255	Dimmer (0% - 100%)
	000-005	Blackout (no output)
2	000-255	Flash Duration (0% - 100%)
3	006-255	Strobe Rate (0-30Hz)
	000-005	No flash

4CH MODE (WHITE COLOR)

Ch.	Value	Funtions
1	006-255	Dimmer (0% - 100%)
	000-005	Blackout (no output)
2	000-255	Flash Duration (0% - 100%)
3	006-255	Strobe Rate (0-30Hz)
	000-005	No flash
4	000-005	Normal flashes
	006-042	Ramp up effect (slow ⇄ fast)
	043-085	Ramp down effect (slow ⇄ fast)
	086-128	Ramp up-down effect (slow ⇄ fast)
	129-171	Random effect (slow ⇄ fast)
	172-214	Lightning effect (slow ⇄ fast)
	215-255	Spike effect

4CH+ MODE (MULTI COLOR)

Ch.	Value	Funtions
1	006-255	Dimmer (0% - 100%)
	000-005	Blackout (no output)
2	000-255	Flash Duration (0% - 100%)
3	006-255	Strobe Rate (0-30Hz)
	000-005	No flash (1 single flash can be triggered with CH1)
4	000-005	No Pixel effects: CH1 to 3 are active (white color flashes)
	006-041	COLOR PIXEL EFFECT 1 (slow ⇄ fast)
	042-083	COLOR PIXEL EFFECT 2 (slow ⇄ fast)
	084-125	COLOR PIXEL EFFECT 3 (slow ⇄ fast)
	126-167	COLOR PIXEL EFFECT 4 (slow ⇄ fast)
	168-209	COLOR PIXEL EFFECT 5 (slow ⇄ fast)
	210-255	COLOR PIXEL EFFECT 6 (slow ⇄ fast)

6CH MODE (MULTI COLOR)

Ch.	Value	Funtions
1	006-255	Master dimmer (0% - 100%)
	000-005	Blackout (no output)
2	000-255	Segment 1+2+3 RED (0% - 100%)
3	000-255	Segment 1+2+3 GREEN (0% - 100%)
4	000-255	Segment 1+2+3 BLUE (0% - 100%)
5	000-255	Flash Duration (0% - 100%)
6	000-255	Strobe Rate (0-30Hz)

7CH MODE (MULTI COLOR)

Ch.	Value	Functions
1	006-255	Master dimmer (0% - 100%)
	000-005	Blackout (no output)
2	000-255	Segment 1+2+3 RED (0% - 100%)
3	000-255	Segment 1+2+3 GREEN (0% - 100%)
4	000-255	Segment 1+2+3 BLUE (0% - 100%)
5	000-255	Flash Duration (0% - 100%)
6	000-255	Strobe Rate (0-30Hz)
7	000-005	No Pixel effects: CH1 to 6 are active
	006-041	COLOR PIXEL EFFECT 1 (slow ⇄ fast)
	042-083	COLOR PIXEL EFFECT 2 (slow ⇄ fast)
	084-125	COLOR PIXEL EFFECT 3 (slow ⇄ fast)
	126-167	COLOR PIXEL EFFECT 4 (slow ⇄ fast)
	168-209	COLOR PIXEL EFFECT 5 (slow ⇄ fast)
	210-255	COLOR PIXEL EFFECT 6 (slow ⇄ fast)

13CH MODE (MULTI COLOR)

Ch.	Value	Functions
1	006-255	Master dimmer (0% - 100%)
	000-005	Blackout (no output)
2	000-005	Segment 1 RED (0% - 100%)
3	000-005	Segment 1 GREEN (0% - 100%)
4	000-005	Segment 1 BLUE (0% - 100%)
5	000-005	Segment 2 RED (0% - 100%)
6	000-005	Segment 2 GREEN (0% - 100%)
7	000-005	Segment 2 BLUE (0% - 100%)
8	000-005	Segment 3 RED (0% - 100%)
9	000-005	Segment 3 GREEN (0% - 100%)
10	000-005	Segment 3 BLUE (0% - 100%)
11	000-005	Flash Duration (0% <--> 100%)
12	000-005	Strobe Rate (0-30Hz)
13	000-005	No Pixel effects: CH1 to 12 are active
	006-041	COLOR PIXEL EFFECT 1 (slow ⇄ fast)
	042-083	COLOR PIXEL EFFECT 2 (slow ⇄ fast)
	084-125	COLOR PIXEL EFFECT 3 (slow ⇄ fast)
	126-167	COLOR PIXEL EFFECT 4 (slow ⇄ fast)
	168-209	COLOR PIXEL EFFECT 5 (slow ⇄ fast)
	210-255	COLOR PIXEL EFFECT 6 (slow ⇄ fast)

1CH PIXEL MODE (WHITE COLOR)

Ch.	Value	Functions
1	000-255	Dimmer (0% - 100%)

3CH PIXEL MODE (MULTI COLOR)

Ch.	Value	Functions
1	000-009	No Function
	010-255	Segment 1+2+3 RED (0% - 100%)
2	000-009	No Function
	010-255	Segment 1+2+3 GREEN (0% - 100%)
3	000-009	No Function
	010-255	Segment 1+2+3 BLUE (0% - 100%)

9CH PIXEL MODE (MULTI COLOR)

Ch.	Value	Functions
1	000-009	No Function
	010-255	Segment 1 RED (0% - 100%)
2	000-009	No Function
	010-255	Segment 1 GREEN (0% - 100%)
3	000-009	No Function
	010-255	Segment 1 BLUE (0% - 100%)
4	000-009	No Function
	010-255	Segment 2 RED (0% - 100%)
5	000-009	No Function
	010-255	Segment 2 GREEN (0% - 100%)
6	000-009	No Function
	010-255	Segment 2 BLUE (0% - 100%)
7	000-009	No Function
	010-255	Segment 3 RED (0% - 100%)
8	000-009	No Function
	010-255	Segment 3 GREEN (0% - 100%)
9	000-009	No Function
	010-255	Segment 3 BLUE (0% - 100%)

MAINTENANCE

- Make sure the area below the installation place is free from unwanted persons during servicing.
- Switch off the unit, unplug the mains cable and wait until the unit has been cooled down.

During inspection the following points should be checked:

- All screws used for installing the device and any of its parts should be tightly fastened and may not be corroded.
- Housings, fixations and installations spots (ceiling, truss, suspensions) should be totally free from any deformation.
- When an optical lens is visibly damaged due to cracks or deep scratches, it must be replaced.
- The mains cables must be in impeccable condition and should be replaced immediately when even a small problem is detected.
- In order to protect the device from overheat the cooling fans (if any) and ventilation openings should be cleaned monthly.
- The interior of the device should be cleaned annually using a vacuum cleaner or air-jet.
- The cleaning of internal and external optical lenses and/or mirrors must be carried out periodically to optimize light output. Cleaning frequency depends on the environment in which the fixture operates: damp, smoky or particularly dirty surroundings can cause greater accumulation of dirt on the unit's optics.
 - Clean with a soft cloth using normal glass cleaning products.
 - Always dry the parts carefully.

Attention: We strongly recommend internal cleaning to be carried out by qualified personnel!

SPECIFICATIONS

This unit is radio-interference suppressed. This product meets the requirements of the current European and national guidelines. Conformity has been established and the relevant statements and documents have been deposited by the manufacturer.

Mains Input:	AC 200 - 240V, 50/60Hz
Power consumption (max):	800 Watt
Fuse:	250V 8A slow blow (20mm glass)
Power connections:	16A Power in/out linking capacity.
DMX connections:	3pin-XLR & 5pin-XLR male / female
DMX channels used:	10 different modes (1ch to 13ch)
Lamp:	1260 RGB leds
Beam Angle:	140° (adjustable with barndoor)
Special effects:	3 segments
IP-Rating:	IP22
Operating temperature (T_a):	0°C to 40°C
Size:	471 x 195 x 274 (237) mm
Weight:	8,5 kg

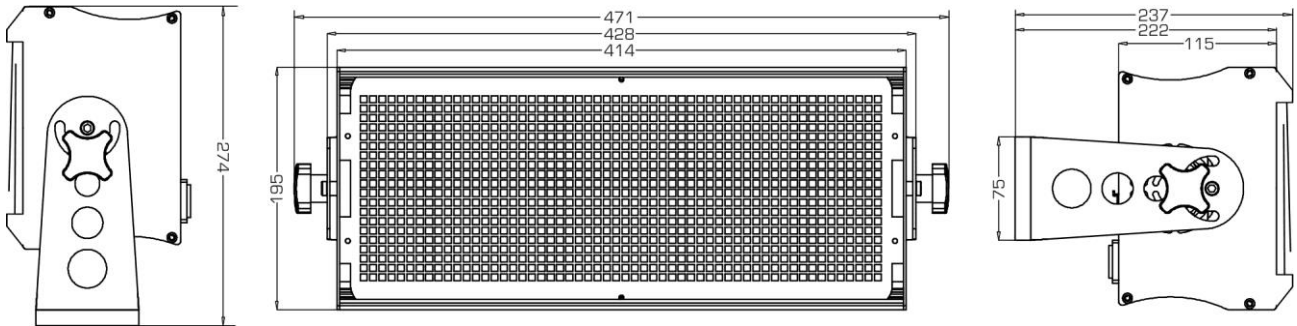

The information might be modified without prior notice

You can download the latest version of this user manual on our website: www.briteq-lighting.com



MAILING LIST

EN: Subscribe today to our mailing list for the latest product news!

FR: Inscrivez-vous à notre liste de distribution si vous souhaitez suivre l'actualité de nos produits!

NL: Abonneer je vandaag nog op onze mailinglijst en ontvang ons laatste product nieuws!

DE: Abonnieren Sie unseren Newsletter und erhalten Sie aktuelle Produktinformationen!

ES: Suscríbete hoy a nuestra lista de correo para recibir las últimas noticias!

PT: Inscreva-se hoje na nossa mailing list para estar a par das últimas notícias!

WWW.BRITEQ-LIGHTING.COM

Copyright © 2017 by BEGLEC NV

't Hofveld 2C ~ B1702 Groot-Bijgaarden ~ Belgium

Reproduction or publication of the content in any manner, without express permission of the publisher, is prohibited.