

USER MANUAL

RevA 08-2015

MULTIMIX LMR-1204-FXC

4M+4S-IN-2 LIVE MIXING DESK
WITH DSP EFFECTS & USB AUDIO

Welcome

Thank you for choosing Hill Audio for your sound system. To make sure that this product meets your expectations and provides long-term, reliable performance, please read and follow this instruction manual carefully.

Manual Language

UK	This user manual is written in English. For other languages, visit	www.hill-audio.com
FR	Ce guide est écrit en anglais. Pour les autres langues, visitez:	www.hill-audio.com
DE	Diese Anleitung ist in Englisch verfasst. Für andere Sprachen:	www.hill-audio.com
ES	Este manual está escrito en Inglés. Para otros idiomas, visite:	www.hill-audio.com
PT	Este manual está escrito em Inglês. Para outros idiomas, visite:	www.hill-audio.com
IT	Questo manuale è scritto in inglese. Per altre lingue, visitare:	www.hill-audio.com

Important safety instructions

- Read these instructions and all markings on the product. Keep these instructions.
- Heed all warnings and instructions, both in this manual and on the product.
- Clean only with a dry cloth. Unplug from AC supply before cleaning.
- Do not use this product near water and avoid any exposure to water.
- Before connecting this product to any AC supply, make sure to check whether the AC mains voltage and frequency match the indication on the product and its packaging.
- Only connect this product to an AC supply with sufficient power handling, protective earth connection, ground-fault (earth-fault) protection and overload protection.
- Disconnect the product from the AC supply during thunderstorms or longer periods of being unused.
- Make sure any heat sink or other cooling surface, or any air convection slot, is exposed sufficiently to free air circulation and is not blocked.
- Do not operate this product in environmental temperatures exceeding 35 degrees Celsius and/or 85% relative humidity.
- Position the product in a safe and stable place for operation, out of reach of unauthorized persons.
- Make sure any cable connections to and from the product are neither subject to potentially destructive mechanical impact nor present any risk of stumbling or other accident risk to people.
- Audio equipment may generate sound pressure levels sufficient to cause permanent hearing damage to persons. Always start up at low volume settings and avoid prolonged exposure to sound pressure levels exceeding 90 dB.
- Do not open this product for service purposes. There are no user-serviceable parts inside. Warranty will be void in any case of unauthorized service by the user or other not authorized persons.
- Take any precaution required by local law, applicable regulations or good business practice to avoid injury of people or material damage by use of this product.

Explanation of symbols used in this manual and on the product:



ATTENTION!
Read manual before installation and operation.



DANGER!
Safety hazard.
Risk of injury or death.



WARNING!
Hazardous voltage.
Risk of severe or fatal electric shock.



WARNING!
Fire hazard.

Description

The LMR1204FX-C-(U) is a versatile audio mixer for stage sound and recording purposes, which is fitted with 4 studio-grade mono mic/line inputs, 4 stereo inputs and 2 subgroups for a well-structured mixdown. All channels sport a full feature set with gain controls, EQs and 2 AUX busses. The mono channels are further equipped with a one-knob compressors and semi-parametric mid-band EQs. A sophisticated DSP effects processor with editable parameters and numerous input/output options complete this unit, which as an option can also be fitted with a stereo USB audio interface [version -U], thus making the LMR1204FX-C-(U) one of the most flexible mixers in its class.

Health advice

This unit produces and absorbs electromagnetic radiation. The strength of radiation and the sensitivity for disturbing interference matches the CE and FCC requirements. A corresponding sign is printed on the backside of the unit. Any change or modification may affect the behavior of the unit concerning electromagnetic radiation, with the CE requirements eventually not to be met any more. The manufacturer takes no responsibility in this case.

Functional advice

This unit is immune to the presence of electromagnetic disturbances – both conducted and radiated - up to a certain level. Under peak conditions, the unit is classified to show a “class C” performance criteria and may encounter temporary degradation or loss of function which may need manual help to recover. In such case, disconnect the AC power from the unit and reconnect it again to recover.

Environmental advice

This unit is built to conform to the ROHS standards and the WEEE directive 2002/96/EC of the European Parliament and of the Council of the European Union. Under these regulations, the product shall not be discarded into regular garbage at the end of its life, but shall be returned to authorized recycling stations.

Unpacking

Please check that the box contains the following items:

Main parts: 1 pc. LMR1204FX-C-(U) main unit
 1 pc. Mains cable
 1 pc. Operation manual
 2 pcs. Rack brackets (optional)

If any part is missing, please contact your dealer immediately for replacement.

Warning



After unpacking, and before plugging the AC cord in the wall outlet, check whether the AC mains voltage and frequency is the same as this product is specified for (see rear panel of product). Whenever the specified voltage or your AC plug should not match the local conditions, do NOT plug the AC cord into the wall outlet and contact your dealer immediately.

Controls and Connections Top

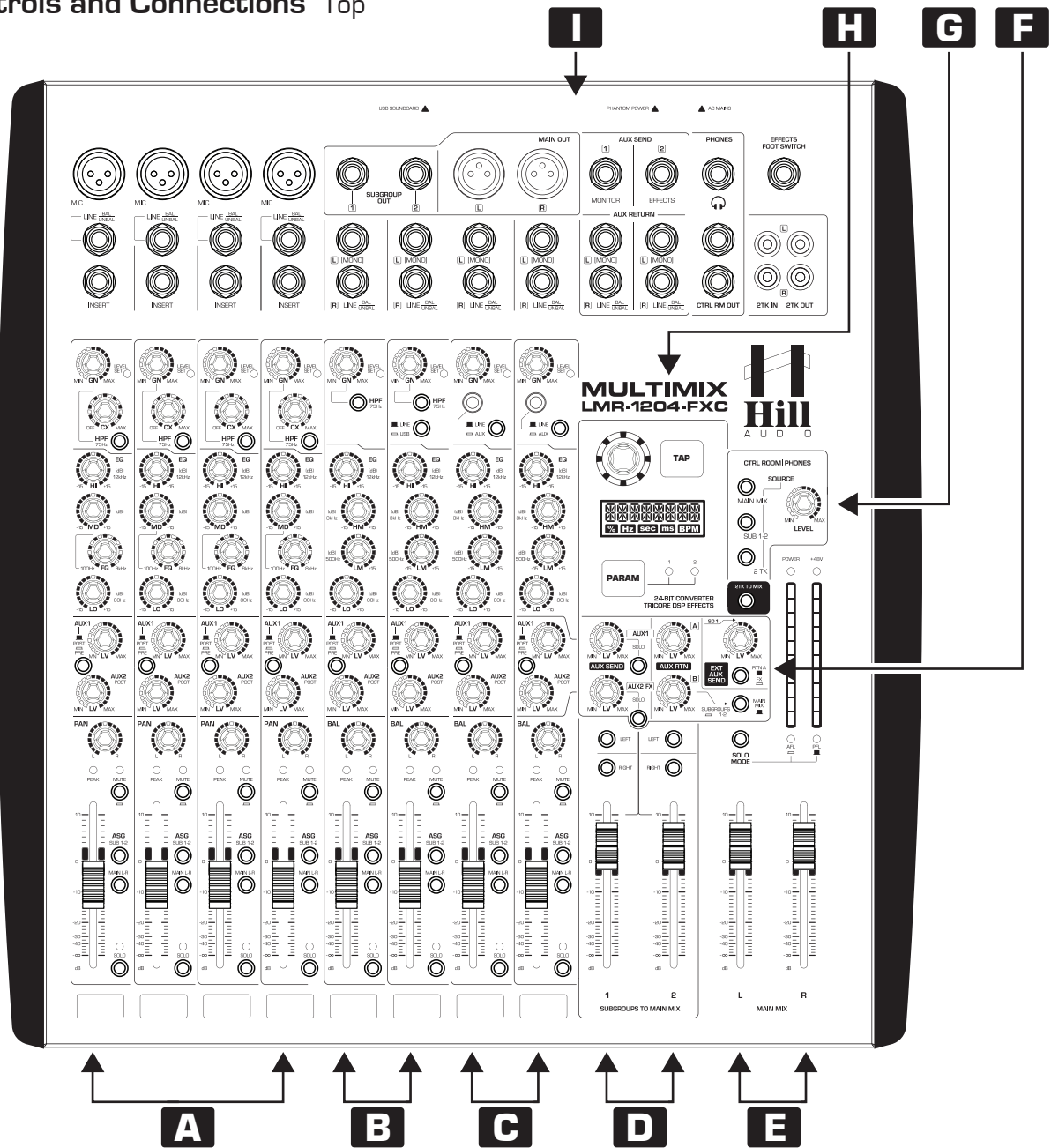

Connections Rear

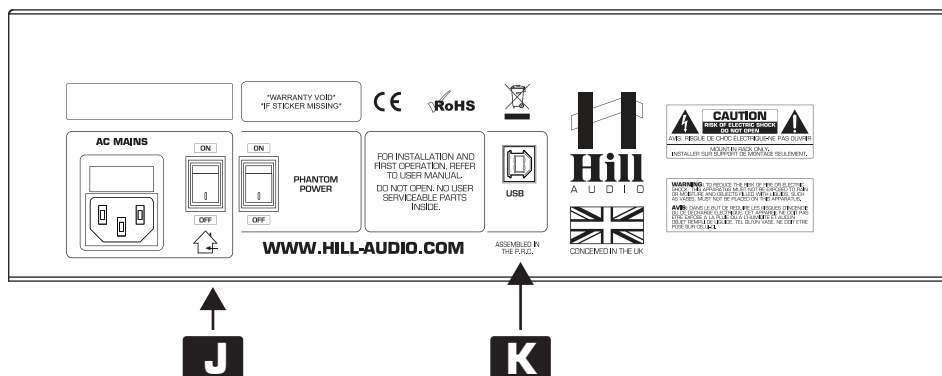

Functional Description

The LMR1204FX-C-(U) is a live sound/recording console with 4 mono and 4 stereo inputs. Each input features gain control, EQ, 2 AUX busses and a stereo pan/balance control. The mono inputs further sport a semi-parametric midband for their EQs and a one-knob compressor. Input channels can be routed to any of the 2 subgroups or directly to the master. One of the AUX buses is routed to an internal effects processor. Numerous in/output options facilitate the integration into any sound system.

A Mono Input Channel

- 1** **1** Microphone Input. This is a balanced female XLR connector. Connect any dynamic or condenser capsule microphone here. Condenser microphones may require phantom power, which can be activated separately via the rear panel switch (section J). Do not connect a microphone to this socket at the same time with a line source in socket (2)
- 2** **2** Line Input. This is a balanced 6.35mm TRS connector. Connect any line level source here. For sources which require a high impedance input (like a guitar output), use a DI box inbetween the source and the mixer's line input. Do not connect a line source to this socket at the same time with a microphone source in socket (1)
- 3** **3** Insert Jack. This is an unbalanced 6.35mm TRS connector, with tip and ring carrying the send and return signal of the insert path at line level respectively. Use a Y TRS cable (insert cable) to insert an external signal processor here.
- 4** **4** Gain control. Adjusts the input gain to achieve the best signal/ noise ratio. Try to set the control in a way that the Level LED (5) shortly lights up at level peaks of the signal. Specifically with line sources, pay attention to whether the source has a volume control. It can be better to use a higher source volume than too much gain at the mixer's input stage.
- 5** **5** Level Set LED. Illuminates once the internal level after the gain control stage exceeds 0dB and helps to set the gain control correctly.
- 6** **6** Compressor. Controls the threshold of the in-built compressor. The ratio is fixed to about 2:1, the gain runs from 0...+9dB and the threshold from +20...-5dB as the control is rotated clockwise. With the +20dB setting in the total counterclockwise position, the compressors can be considered "off" since if the gain control is set correctly, the signal will not exceed this threshold. Once a signal exceed the threshold, the peaks exceeding the threshold will be reduced to half while the gain is raised, giving the signal more perceived volume while reducing its dynamics. The attack time is fixed at approx. 25 msec, the release time is fixed at approx. 300 msec, the characteristic is "hard knee".
- 7** **7** High Pass Filter. Pressing this switch engages a 75Hz high pass filter, effectively suppressing AC hum or microphone rumble.
- 8** **8** Hi EQ level control. This is a shelving filter with a corner frequency of 12kHz, thus allowing to boost or attenuate all frequencies above this point by -15dB to +15dB.
- 9** **9** Mid EQ level control. This is the level control of a semi-parametric mid frequency equalizer. The frequency set by the frequency control (10) can be boosted or attenuated by -15 to +15dB.

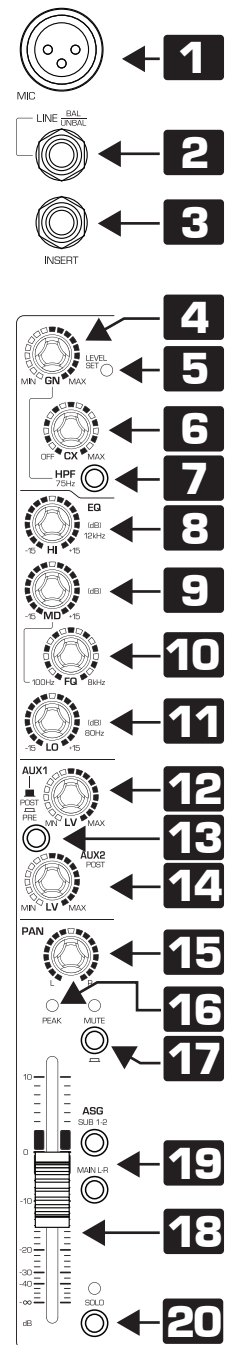

- 10** Mid EQ frequency control. Sets the center frequency of the semi-parametric mid frequency equalizer between 100Hz and 8kHz.
- 11** Lo EQ level control. This is a shelving filter with a corner frequency of 80Hz, thus allowing to boost or attenuate all frequencies below this point by -15dB to +15dB.
- 12** AUX controls. The AUX busses allow to generate independent mixes from the main mix, either with the target to send different amounts of the channel signals to an internal or external effects processor, or in order to create a mix different from the main mix for monitoring purposes. Generally, since the part of a channel signal which runs through an effects processor shall be in a fixed ratio to that same channel signal, so-called “post fader” AUX busses are used to feed effect processors, which means the eventual signal level sent into the BUS depends on both the AUX level setting as well as on the channel’s fader position. For monitoring purposes, it is generally desirable to create a completely independent mix from the main signal, hence the signal level sent into the AUX bus shall not depend on the fader position of the respective channel; this is called “pre-fader”. On this unit, the AUX1 buss (12) is switchable between pre&post fader routing via the selector switch (13), while the AUX2 buss (14) has a fixed post-fader routing. AUX2 is as well connected to the internal effects processor.
- 13**
- 14**
- 15** PAN control. This control allows to position the channel signal in the stereo image. Turning the control counterclockwise will move the signal more to the left output, turning it clockwise will move the signal more to the right output. The center position sends the signal in equal shares to the left and right output. Note that “left” and “right” may be inversed if the channel is routed to a subgroup and the subgroup is assigned to the main bus in an inverted manner.
- 16** PEAK Indicator. This indicator will flash if the signal level exceeds +6dB. To allow for distortion-free operation, the user shall avoid the Peak indicators to flash more than occasionally.
- 17** MUTE function. Pressing this button will mute the respective channel. The LED above the switch indicates once a channel is muted.
- 18** CHANNEL FADER. Controls the channel’s level in the overall mix.
- 19** ROUTING switches. These switches allow the channel signal to be either sent directly to the main output (switch “LR”) or to the subgroups 1&2. Once 1&2 is selected, the eventual distribution of the signal level between 1-2 will depend on the PAN control (15). If for example 1&2 is selected, then turning the PAN control more counterclockwise will send more signal to subgroup 1, turning clockwise more signal to subgroup 2.
- 20** SOLO function. The SOLO function allows to mute all channels on which SOLO is not selected, in one go. This helps to “isolate” a specific channel to make adjustments to the level or EQ settings. A LED indicator is lit when SOLO is active.

B Stereo Input Channels

C Most controls and functions of the stereo channels are identical to the mono channels, with the exception of no compressors provided and other differences outlined below. For any not listed item, refer to the mono channel section.

4 Gain control. Like in the mono channels, this adjusts the input gain to achieve the best signal/noise ratio. Try to set the control in a way that the Level LED (5) shortly lights up at level peaks of the signal. Specifically with line sources, pay attention to whether the source has a volume control. It can be better to use a higher source volume than too much gain at the mixer's input stage.

21 Line Input. These are two balanced 6.35mm TRS connectors. Connect any line level stereo source here.

22 USB Source selector (only channel 7-8). Pressing this button will route the channel to the output of the internal USB audio interface. Note that the input jacks (21) are disabled when this button is pressed.

23 AUX Input and source selector (only channel 9-10 and 11-12). These channels have a 3.5mm stereo TRS (unbalanced) input, suitable for the connection of e.g. MP3 players. This AUX input is activated by pressing the relative button, in this case the channel's stereo TRS inputs (21) are disabled.

24 High-Mid EQ. This is a fixed frequency peaking EQ, with a center frequency of 3 kHz.

25 Low-Mid EQ. This is a fixed frequency peaking EQ, with a center frequency of 500 Hz.

26 BALANCE control. This control allows to position the channel signal in the stereo image. Turning the control counterclockwise will balance the signal more to the left output, turning it clockwise will balance the signal more to the right output. The center position sends the left channel of the signal to the left main output and the right channel of the signal to the right main output. Note that "left" and "right" may be inverted if the channel is routed to a subgroup and the subgroup is assigned to the main bus in an inverted manner.

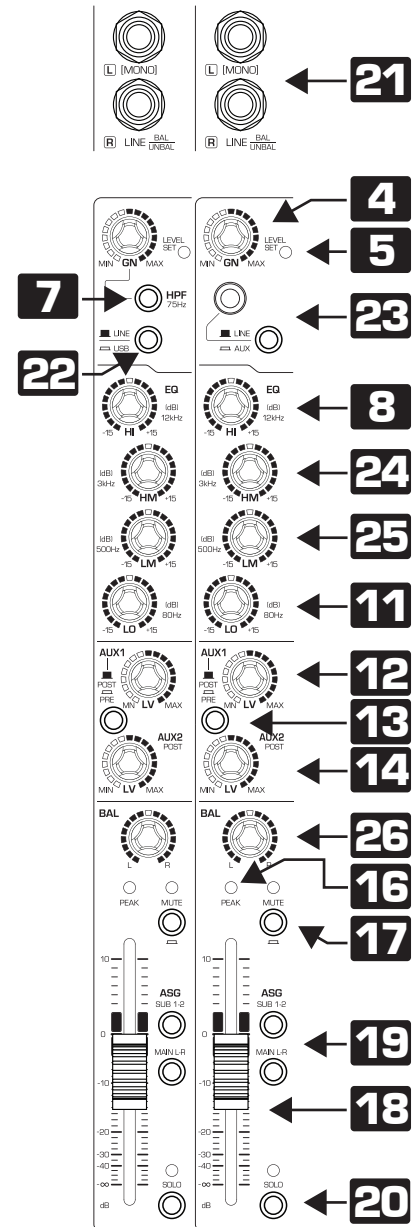

Master Section

I
TOP PANEL CONNECTIONS

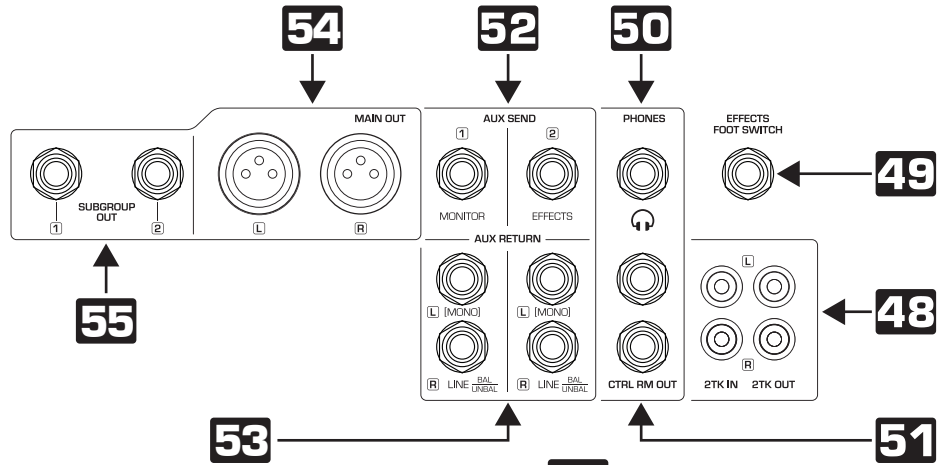

H
EFFECTS

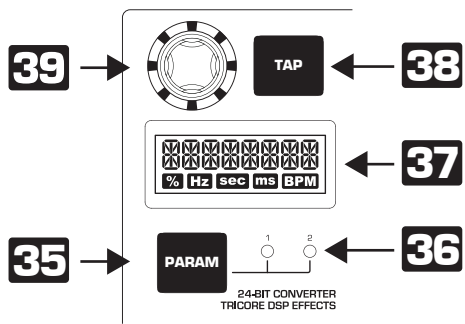

G
CONTROL ROOM

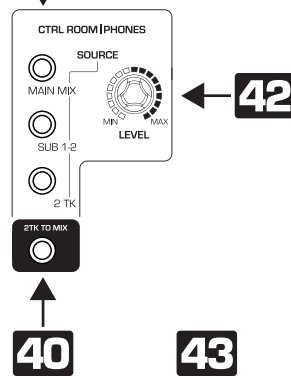

E
MASTER

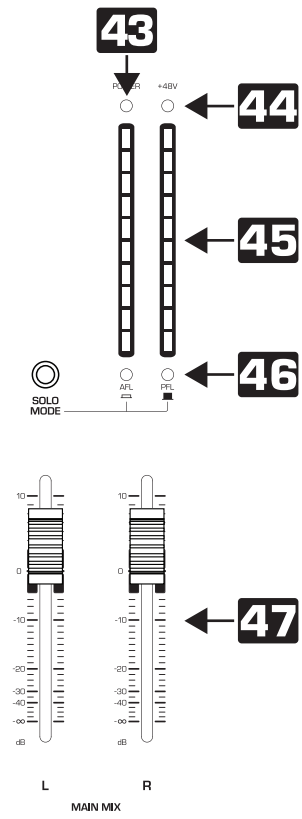

F
AUX SECTION

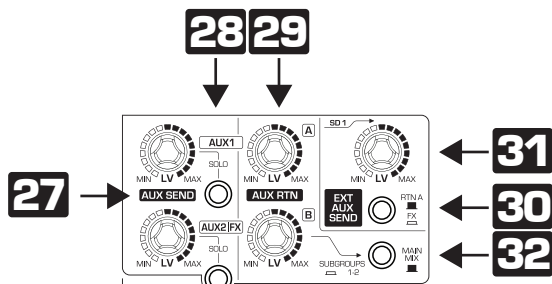

D
SUBGROUPS

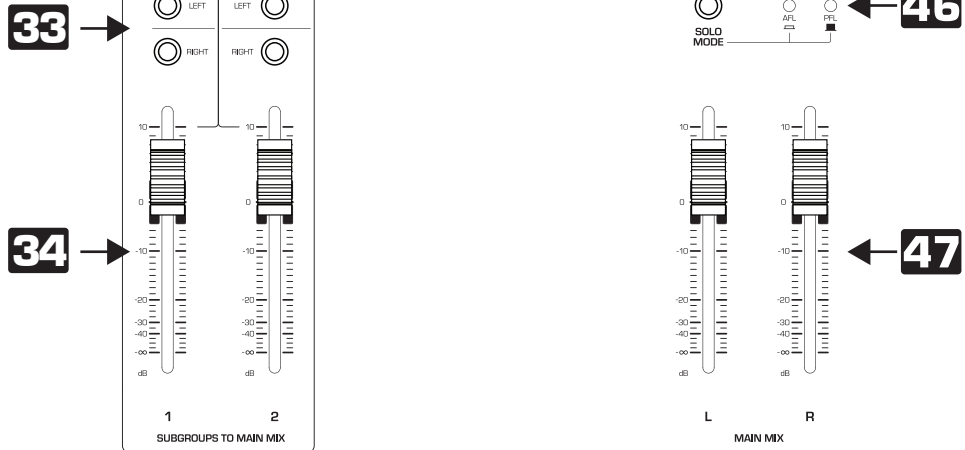

- 27** AUX SEND (1-2). These controls determine the overall output level of the AUX bus, with ratios of the different channel contributions set by the channel AUX controls (12&14). The AUX bus signal is then sent to either the external AUX SEND connectors (for AUX1) on the top panel (section I) or to both the external AUX SEND connector on the top panel (section I) and the internal effects processor (AUX 2).
- 28** AUX Send SOLO. Pressing any of these buttons will put the relative AUX Send into SOLO mode, allowing to mute all sources on which SOLO is not selected, in one go. This helps to “isolate” a specific source to make adjustments to the level or other settings.
- 29** AUX RETURN. This sets the level for the signals coming in through the top-panel RETURN inputs (section I). Note these signals can both be mono or stereo, depending on the connected sources in section I. If no source is connected to the AUX-RTN-B input on the top panel, then RTN-B carries the output of the internal effects processor. Note that these inputs are independent from the AUX SEND signal and might receive any signal, also others than what has been sent through the relative AUX SEND. For RTN-A, it can also be fed back into SEND-1 respectively with the volume set by the control (31), if the selection switch (30) is not pressed.
- 30** EXTERNAL AUX SEND selector switch. This switch determines which signal is fed back into the AUX-1 bus via the level control (31). Either the RTN-A or the internal effects can be chosen. This allows to feedback either an externally or internally generated effect into the AUX-1 bus, which due to its pre-fader routing primarily serves for monitoring purposes.
- 31** EXTERNAL AUX SEND volume control. Determines which level of the signal set by the selector switch (30) is fed into the AUX-1 bus.
- 32** AUX-RETURN routing switches. While RTN-A goes straight to the main output, the routing for RTN-B is more flexible. Aux Return B can be routed to the main mix or control room, and is automatically routed to the output of the internal effects processor as well.
- 33** SUBGROUP ASSIGN switches. These switches assign any of the subgroups to either the left or the right side of the master signal (or both). Please note that for the use of the PAN (15) and BALANCE (26) controls in the input channels, it is assumed that subgroup 1 is routed to the left side of the master, while subgroups 2 is routed to the right side of the master. If you happen to set this switch (33) in a different manner, the left-right stereo imaging of a channel may reverse.
- 34** SUBGROUP FADER. Determines the total level of the respective subgroup signal, both in the main mix as well as at the subgroup outputs on the rear panel (section I).
- 35** EFFECTS PARAMETER button. The choice of the parameter to be edited can be made here, the current parameter under editing is shown by the parameter indicators (36).
- 36** PARAMETER INDICATORS. Show which of the available parameters is chosen for editing via the switch (35).
- 37** Effects processor display. Indicates all important information about the effects status.
- 38** EFFECTS TAP TEMPO button. This allows to tap along with the music to set a time-relevant parameter (if available) in the chosen effect algorithm. For effects where no time-base parameter is available, this button is used to set a 3rd effects parameter. For all effects with a tap-settable time base, the rear illumination of this button will flash with the speed of the set timebase. See below algorithm table for more information.

- 39** EFFECTS DATA DIAL. Turning this infinite control scrolls through the list of available effect algorithms (see list below), and the currently pre-selected algorithm's name will flash in the display unless it is either confirmed by pressing the dial or dismissed if no further action is taken. The DATA DIAL also serves to adjust a parameter of the effect if the EFFECTS PARAMETER button (35) is pressed first and a parameter is chosen by consecutively pressing the EFFECTS PARAMETER button (indicated by 37) for editing. The DATA DIAL then allows to change the parameter value and to confirm the change by pressing the dial. In case no confirmation is invoked, the parameter will remain unchanged and the display (37) will return to indicate the current algorithm name.
- 40** 2TR to Mix button. This routes the 2 Track stereo RCA inputs (48) to the main mix. The level of this input is controlled by the output level of the external audio device.
- 41** CONTROL ROOM & HEADPHONES SOURCE SELECTOR. These buttons determine whether the Master, Subgroups and/or 2 Track inputs are routed to the control room/headphone outputs.
- 42** CONTROL ROOM & HEADPHONES VOLUME. Sets the level at the control room and headphone outputs (section I).
- 43** POWER INDICATOR. Indicates whether the unit is switched on or off, in response to the POWER switch setting (section J).
- 44** PHANTOM POWER INDICATOR. Indicates whether the phantom power supply is switched on or off, in response to the PHANTOM POWER switch setting (section J).
- 45** MAIN LEVEL METERS. Show the output level in 10 steps on a LED bargraph meter.
- 46** SOLO MODE SWITCH and INDICATORS. This button allows you to switch the solo mode between After Fader Listen (AFL) and Pre Fader Listen (PFL) operations. When the button is pressed, the signal will be routed from the solo sources post-fader and the AFL LED will be lit. This means that the position of the channel fader(s) that is being soloed will determine the level heard when monitoring this channel in the Control Room and Headphones. When the Solo Mode button is not pressed, the solo will be in Pre Fader Listen (PFL) mode and the PFL LED will be lit. Use the solo function in PFL for setting the gain on inputs and use AFL for normal soloing operations, such as reviewing an individual or selected number of channel input signals to hear how they sound before they are routed to the main mix.
- 47** MASTER FADER. Controls the volume of the main mix at the outputs in section I.
- 48** 2TR In-Out. This is an unbalanced RCA stereo connector for a tape or solid state recorder in order to record from the main mix and replay into the main mix.
- 49** EFFECTS FOOT SWITCH. Allows to enable/disable the internal effects processor via an external foot switch.
- 50** HEADPHONES OUTPUT. Connect standard stereo headphones (min 32 Ohm impedance) here to listen to the signal determined by the respective controls (41, 42).
- 51** CONTROL ROOM OUTPUT. This is a pair of TRS connector carrying the signal determined by the respective controls (41, 42).
- 52** AUX SEND. Every AUX bus has a balanced TRS output which carries the signal composed from the channel AUX bus controls and the AUX SEND level controls (27).

- 53** **AUX RETURN.** Two AUX Return inputs are provided for connecting any sort of mono or stereo line level signal. The level of these inputs is adjusted by the respective RETURN controls (29). Insert a mono source into the L jack of any pair to make sure the signal is fed into both L and R main mix. Note that for AUX-RTN-B, inserting any connector into these sockets will disable the internal effects processor's output to be fed into the main mix. Also note that AUX-RTN-B has no automatic mono/stereo switching function, and is hence mainly suitable for stereo input signals.
- 54** **MAIN OUTPUT section.** This contains a pair of XLR outputs which carry the balanced main mix signal.
- 55** **SUBGROUP OUTPUTS.** Every subgroup has a balanced TRS output jack.

Rear Panel Connections / Elements

- J** **POWER SECTION.** The IEC wide-range AC power inlet, the mains power switch (status indicated by LED 43) and the phantom power switch (status indicated by LED 44) are located here.

- K** **USB INTERFACE.** This unit may be fitted with a built-in stereo in/out soundcard.

To play back audio:

- Connect your computer to the mixer with a USB cable. Your computer should see the mixer as a device labeled "USB Audio Codec".
- Select the mixer to playback audio from your system control panel.
- Channels 7/8 are the playback channels for USB audio. Press the USB source button (22) on this channel so that audio will playback.

To record audio

- Connect your computer to the mixer with a USB cable. Your computer should see the mixer as a device labeled "USB Audio Codec".
- Select the mixer to playback and record audio from your system control panel.
- Setup your mixer to have audio coming in as you normally would.
- Start up your DAW application on your computer. Make sure it is setup to receive audio from the USB Audio Codec (the mixer)
- Create an audio track on your mixer and enable it to record. To avoid a feedback loop turn down the fader on channel 7/8 or switch the USB source button (22) to off.
- Perform your audio on the mixer and record the track on your DAW application. Note that different operation systems may need different gain settings. Set the gain carefully to avoid signal overload and distortion.

Effect Algorithms / Parameters

Preset	Name	Variable Parameter	Tap Control	Description
1	CHORUS	Depth, Speed	Wav Shape Tri/Sine	Chorus ensemble effect with short delays
2	FLANGER	Depth, Res	Oscillation Speed	Classic stereo flanger with a slow sweep
3	PHASER	Depth, Res	Oscillation Speed	Modulated sweeping effect
4	TREMOLO	Depth	Oscillation Speed	Rapid reiteration of a note producing prominent overtones
5	DELAY	Feedback, Mod	Delay Time	Simple mono delay, great for vocals and guitars
6	ECHO	Time, Damp	Delay Time	Classic echo effect. Reflection of sound
7	RV-ROOM 1	Time, Pre Delay	Dampening Bright/Dark	Emulates a small studio room, great for adding ambience to drums and instruments
8	RV-ROOM 2	Time, Pre Delay	Dampening Bright/Dark	Emulates a large studio room, great for adding ambience to drums and instruments
9	RV-CHAM	Time, Pre Delay	Dampening Bright/Dark	Gives the sound of a classical chamber, ideal for string, and wind instruments
10	RV-THEAT	Time, Pre Delay	Dampening Bright/Dark	Gives the sound of a large theatre, great for adding ambience to instruments and vocals
11	RV-HALL	Time, Pre Delay	Dampening Bright/Dark	Gives the sound of a concert hall, ideal for keyboards, string, and wind instruments
12	RV-CHURCH	Time, Pre Delay	Dampening Bright/Dark	Gives the sound of a Church, ideal for keyboards, string, and wind instruments
13	RV-PLATE	Time, Pre Delay	Dampening Bright/Dark	Emulation of a 70's plate reverb - a smooth decay for instruments
14	RV-SPRING	Time, Threshold	Dampening Bright/Dark	The sound of a spring reverb, adds a funky vintage sound to guitars
15	RV-GATED	Time, Pre Delay	Dampening Bright/Dark	Gated ambience. Applicable to vocals and instruments
16	DETUNE	Detune, Pre Delay	Dampening Bright/Dark	Slow pitch modulation with saturation
17	PSHIFTX1	Pitch Shift, Pre Delay	Detune On/Off	Pitch modulation with pre delay
18	PSHIFTX2	Shift A, Shift B	Spread Narrow/Wide	Pitch Modulation variation
19	VOCDBLER	Detune, Delay	Spread Narrow/Wide	Vocal doubler effect - a Pitch Shifter with a slight echo to fatten vocals or guitars
20	DEL-CHOR	Bal, Depth	Delay Time	Mono Delay with Chorus effect
21	REV-MDEL	Bal, Time	Delay Time	Mono Delay with Reverb
22	REV-PDEL	Bal, Time	Delay, Time	Reverb with a short stereo ping-pong delay
23	REV-CHOR	Bal, Time	Oscillation Speed	Reverb and Chorus multi-effect, nice on keyboards
24	REV-FLGR	Bal, Time	Oscillation Speed	Reverb with flanger multi-effect, interesting with guitar
25	REV-VOCD	Bal, Detune	Dampening Bright/Dark	Reverb with vocal doubler multi-effect, great for pop vocals

Operation

A. Connections

For connecting this unit to AC mains, please note:

- Check whether the AC mains voltage and frequency is the same as this product is specified for (see rear panel of product). Whenever the specified voltage or your AC plug should not match the local conditions, do NOT plug the AC cord into the wall outlet and contact your dealer immediately.
- Do not operate this unit without the line cord earth ground connected. To do so may increase the risk of electric shock and increase line cord conducted emissions.

For making audio signal connections, always remember that good and reliable connections are a basic requirement for good sound and reliable operation. Bad soldering of cables can result in intermittent audio signals or temporarily lost ground connections, hence always use good cables. In case of doubt about making proper connections, please see the standard pin assignments required for proper operation in the following section of this manual.

B. Powering up

Following a proper power-up sequence protects your equipment – specifically speakers – and your ears. Follow the below procedure:

- Turn down all output volume controls of any equipment in your audio system.
- Switch on your audio sources first (Tuners, CD Players, PC's with soundcards, Tapedecks, etc.)
- Switch on the audio mixer
- Switch on any audio processor between the mixer and the amplifier(s) [if any].
- Switch on the amplifier(s).
- Turn up the audio level on your sources if such controls are provided.
- Set the audio output of your mixer to a low level.
- Set the audio output of any audio processor between the mixer and the amplifier(s) to a medium level [if any such processors].
- Turn up the volume controls of your amplifier(s) slowly.
- Make adjustments to all volume settings as needed.

For switching off, follow the inverse sequence – always switch off your amplifier(s) first, then any processors between mixer and amplifier(s), then the mixer, then the sources.

C. Use

Apart from using good equipment, good sound comes from using it correctly. Level setting mistakes are one of the common reasons why even good equipment may not perform as desired. For setting levels, please be reminded that two guidelines need to be followed:

- Avoid distortion by leaving some headroom. Never overrun any audio-equipment's inputs. Level meters and displays allow you to make sure that signals do not enter critical levels.
- Avoid unnecessary amplification by using as little attenuation as possible. For example, if you turn down the input gain of a mixer to minimum, and then increase the main output of the mixer to maximum to drive your amplifier properly, you will create unnecessary noise, as you first dispose of some already existing signal level, and then later apply amplification [tainted with noise] to make it up.

Obviously, these two requirements are marking a levelling window that the operator must match to achieve a good sound with as little distortion and noise as possible.



WARNING - HEALTH RISK

Excessive volume levels on headphones or other sound systems may cause hearing damage. Always turn the volume control to minimum when you switch the unit on, and avoid prolonged exposure to sound pressure levels exceeding 90dB.

Connections

This product uses the below connector types, for which the pin assignment must comply with the following specification. Always make sure to use good connectors and cables to ensure proper operation. Balanced connections are to be preferred over unbalanced connections where applicable and feasible. Avoid unbalanced connections exceeding 2m of cable length.

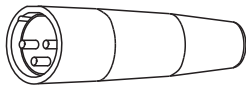
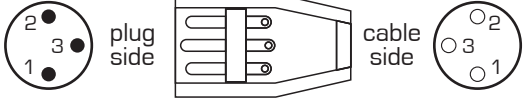
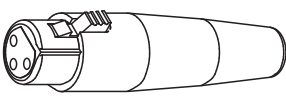
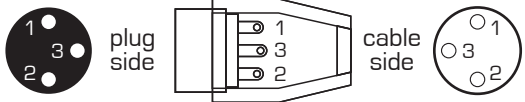
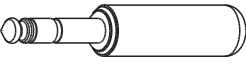
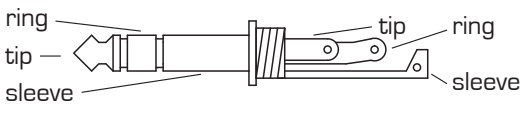
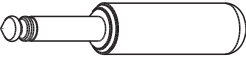
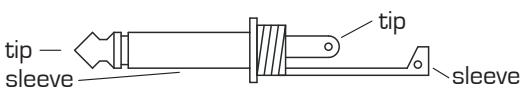
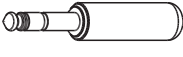
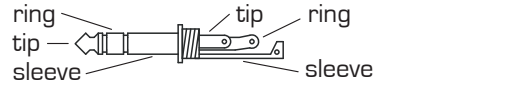
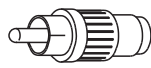
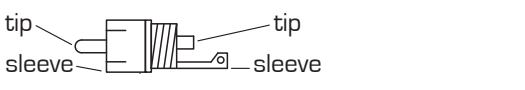
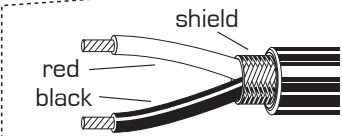
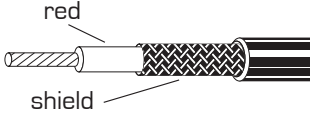
	Structure	Balanced connection	Unbalanced connection
XLR male 		red = 2 black = 3 shield = 1	red = 2 shield = 1+3
XLR female 		red = 2 black = 3 shield = 1	red = 2 shield = 1+3
6.35mm TRS-stereo 		red = tip black = ring shield = sleeve	red = tip shield = sleeve+ring
6.35mm TRS-mono 		red = tip black = sleeve shield = uncon.	red = tip shield = sleeve
3.5mm TRS-stereo 		red = tip black = ring shield = sleeve	red = tip shield = sleeve+ring
RCA 		red = tip black = sleeve shield = uncon.	red = tip shield = sleeve
CABLE Types	 <p>2-conductor shielded cable (for balanced connections)</p>	 <p>1-conductor shielded cable (for unbalanced connections)</p>	

Technical Specifications

Preamp Noise (EIN) 20 Hz to 20 kHz, (150Ω source).....-114dB
 Residual Output Noise All level controls @ minimum.....-95dB
 Crosstalk Same channel (stereo separation).....-70dB
 Frequency response +0 / -1dB.....10Hz-22kHz

THD Mic In to Main Out, 20Hz to 20kHz.....0.007%
 AC IN (EU version).....AC110-250V ~ 50-60Hz
 Dimensions (with plastic side covers).....W394xH412xD103mm
 Weight4.80kg

Block Diagram

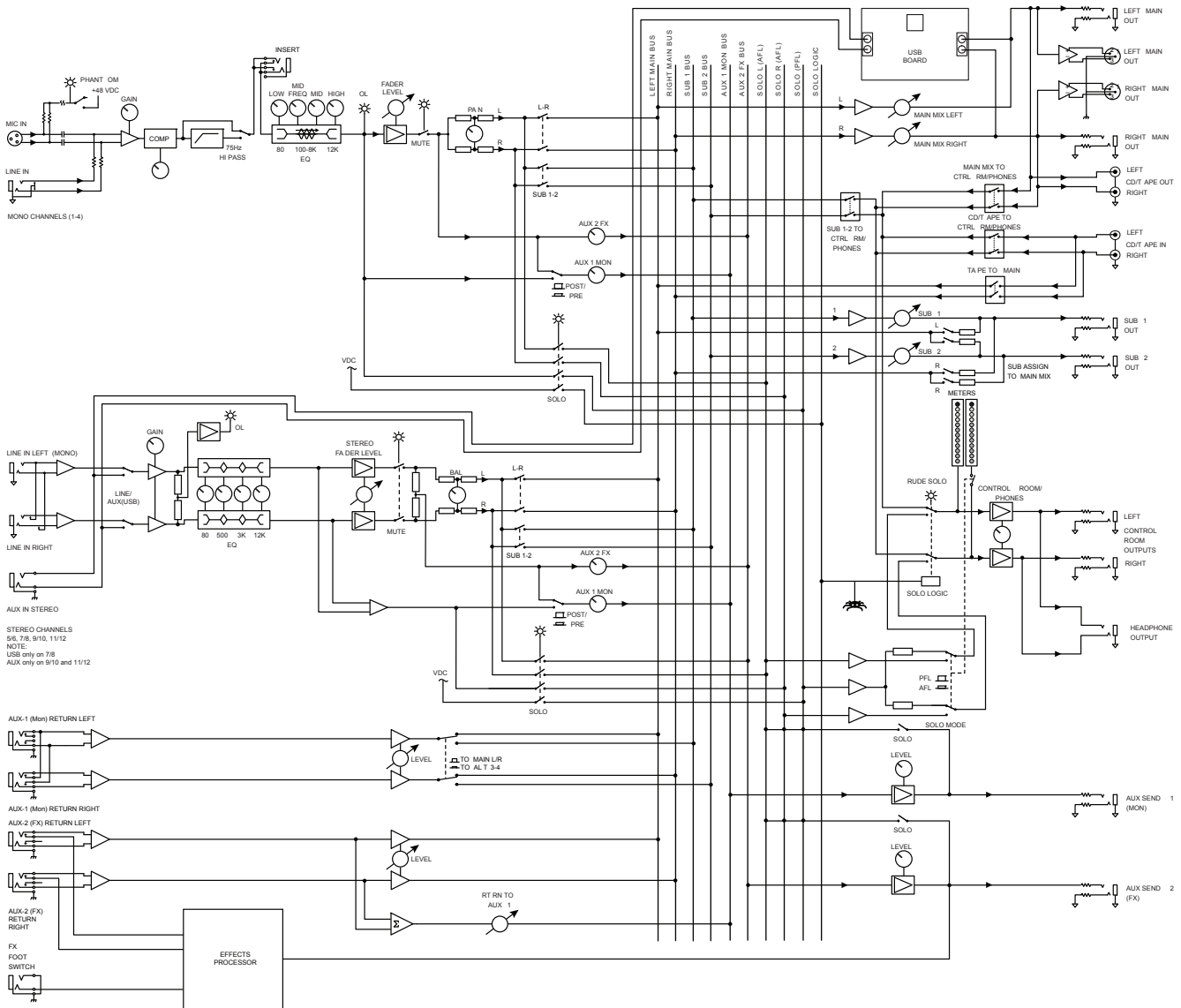

Maintenance and warranty

While we have chosen the best components to make this product as rugged and reliable as possible, some parts in audio products (potentiometers, faders, switches) are subject to wear which is a matter of operation cycles, and not of time. While providing a full time-based warranty according to the country's of purchase requirements on the function of the electronic circuitry, we hence have to limit the warranty on such electro-mechanical parts to 90 days from the date of purchase.

In many cases, malfunction of electro-mechanical parts occurs due to dust contamination, which may require cleaning of such parts. As the inside of such parts is not accessible, a common practice is to use cleaning fluids in the shape of sprays. Please be reminded that many of such fluids contain chemicals which may wash away the dust but at the same time corrode or damage contact surface and may cause cosmetic damage to other parts. We hence explicitly exclude any claims for exchange of damaged part due to mechanical or chemical impact.

EC Declaration of Conformity

Manufacturer: Adelto Technologies Limited
Address: Unit 2A Springfield Road, Springfield Industrial Estate
Burnham-on-Crouch, Essex CM08UA, England

We declare on our own responsibility, that the equipment

Hill Audio LMR1204-FXC-U

is in conformity with the following directives and standards or regulations:

EMC Directive 2004/108/EC

EN55103-1:2009 (Emissions)

EN55103-2:2009 (Immunity)

EN61000-3-2:2006 + A1:2009 + A2:2009

EN61000-3-3:2008

LVD Directive 2006/95/EC

EN60065:2002 A1:2006 + A11:2008 + A2:2010

ROHS Directive 2002/95/EC

and is marked as follows:



Burnham-on-Crouch, 10.09.2015
Place and date of issuing

Authorized Signature

www.hill-audio.com



Hill Audio products are developed, manufactured and distributed by
Adelto Technologies

Unit 2A Springfield Road, Springfield Industrial Estate, Burnham-on-Crouch, Essex CM08UA, England
www.adelto.com | sales@adelto.com