

# LEDJ

## **Spectra Par 12HEX10**

### **Exterior Fixture**

### **User Manual**



**Order code: LEDJ283**

**WARNING****FOR YOUR OWN SAFETY, PLEASE READ THIS USER MANUAL CAREFULLY BEFORE YOUR INITIAL START-UP!**

- Before your initial start-up, please make sure that there is no damage caused during transportation.
- Should there be any damage, consult your dealer and do not use the equipment.
- To maintain the equipment in good working condition and to ensure safe operation, it is necessary for the user to follow the safety instructions and warning notes written in this manual.
- Please note that damages caused by user modifications to this equipment are not subject to warranty.

**IMPORTANT:**

**The manufacturer will not accept liability for any resulting damages caused by the non-observance of this manual or any unauthorised modification to the equipment.**

- Never let the power cable come into contact with other cables. Handle the power cable and all mains voltage connections with particular caution!
- Never remove warning or informative labels from the unit.
- Do not open the equipment and do not modify the unit.
- Do not connect this equipment to a dimmer pack.
- Do not switch the equipment on and off in short intervals, as this will reduce the system's life.
- Do not expose to flammable sources, liquids or gases.
- Always disconnect the power from the mains when equipment is not in use or before cleaning! Only handle the power-cable by the plug. Never pull out the plug by pulling the power-cable.
- Make sure that the available mains supply voltage is between 100~240V AC, 50/60Hz.
- Make sure that the power cable is never crimped or damaged. Check the equipment and the power cable periodically.
- If the equipment is dropped or damaged, disconnect the mains power supply immediately and have a qualified engineer inspect the equipment before operating again.
- If your product fails to function correctly, stop use immediately. Pack the unit securely (preferably in the original packing material), and return it to your Pro Light dealer for service.
- Only use fuses of same type and rating.
- Repairs, servicing and power connection must only be carried out by a qualified technician. **THIS UNIT CONTAINS NO USER SERVICEABLE PARTS.**
- This lighting fixture is for professional use only - it is not designed for or suitable for household use. The product must be installed by a qualified technician in accordance with local territory regulations. The safety of the installation is the responsibility of the installer. The fixture presents risks of severe injury or death due to fire hazards, electric shock and falls.
- Warning! Risk Group 2 LED product according to EN 62471. Do not view the light output with optical instruments or any device that may concentrate the beam.
- **WARRANTY:** One year from date of purchase.

**OPERATING DETERMINATIONS**

If this equipment is operated in any other way, than those described in this manual, the product may suffer damage and the warranty becomes void. Incorrect operation may lead to danger e.g: short-circuit, burns and electric shocks etc.

Do not endanger your own safety and the safety of others!

Incorrect installation or use can cause serious damage to people and/or property.

### Spectra Par 12HEX10



The exterior Spectra Par 12HEX10 features 12 x 10W six-colour LEDs, delivering a smooth wash of colour, ranging from intense, rich saturated hues through to pastel shades. Controllable via the onboard 4 button LED menu system for auto, static colour or master/slave modes, with the option of DMX control for larger installations. The silent running, convection cooled heavy-duty alloy enclosure features IP65 rated connectors for both DMX and mains input/output.

- 12 x 10W six-colour LEDs (RGBWAUV)
- Beam angle: 28°
- 4,374 Lux @ 2m (full on)
- 1kHz refresh rate
- DMX channels: 6, 8 or 10 selectable
- Static colour, colour change, colour fade and master/slave modes
- 0 - 100% dimming and variable strobe
- 4 push button menu with LED display
- IP rated power input/output
- IP rated 3-Pin DMX input/output

Specifications	Spectra Par 12HEX10
Power consumption	130W
Power supply	100~240V, 50/60Hz
Dimensions	340 x 295 x 170mm
Weight	4.53kg
Order code	LEDJ283



28° - Lux					
FULL ON	17496	4374	1944	1093	699
R	2672	668	296	167	106
G	5536	1384	615	346	221
B	1192	298	132	74.5	47.6
W	5864	1466	651	366	234
A	3396	849	377	212	135
UV	N/A	N/A	N/A	N/A	N/A

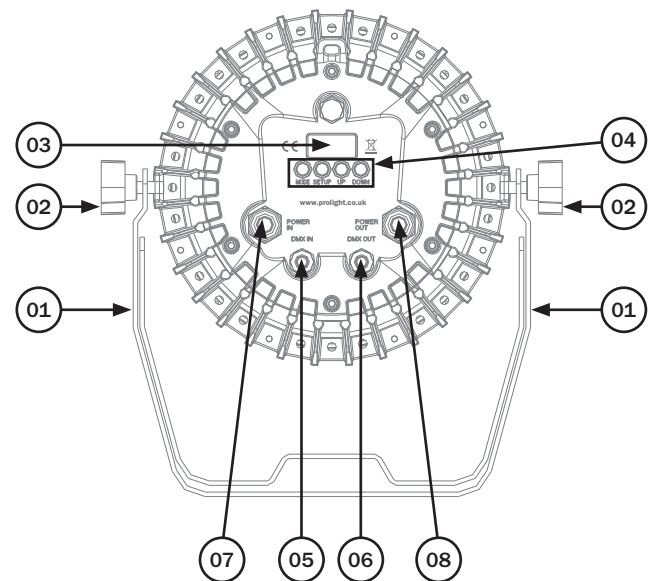
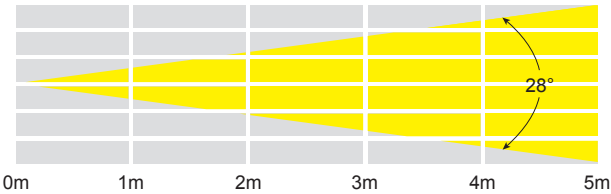

- 01 - Bracket
- 02 - Bracket tightening knobs
- 03 - LED display
- 04 - Function buttons
- 05 - IP rated DMX input
- 06 - IP rated DMX output
- 07 - IP rated power input
- 08 - IP rated power output

In the box: **1 x fixture,**  
**1 x power cable &**  
**1 x user manual**

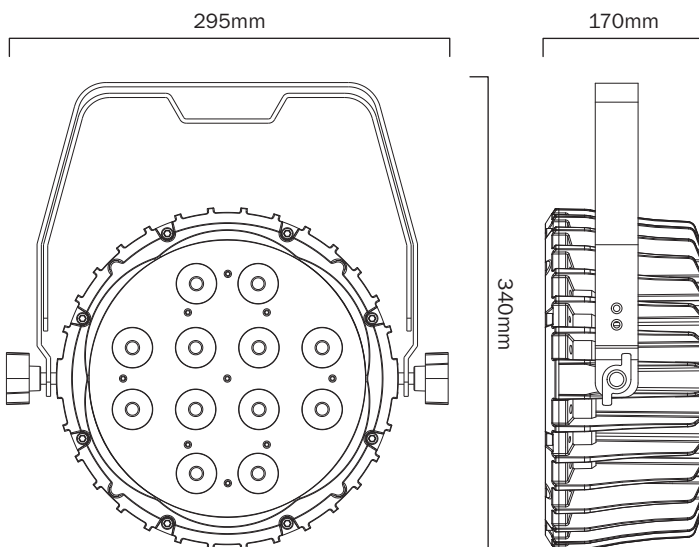

**IMPORTANT! PLEASE NOTE:** The LED display for this fixture has a menu locking function where after 30 seconds of inactivity it will lock. To unlock the menu hold the **“MODE”** and **“DOWN”** buttons for 3 seconds.

### DMX channel mode:

Operating in a DMX control mode environment gives the user the greatest flexibility when it comes to customising or creating a show. In this mode you will be able to control each individual trait of the fixture and each fixture independently.

To access the DMX channel mode, press the **“MODE”** button on the rear of the unit to show **000 1** on the LED display. Now use the **“UP”** and **“DOWN”** buttons to set the desired DMX address. Now press the **“SETUP”** button to choose one of the 6, 8 or 10 DMX channel modes, press the **“SETUP”** button to confirm the setting. To exit out of any of the above options, press the **“MODE”** button.

### 6 channel mode:

Channel	Value	Function
1	000-255	Red (0-100%)
2	000-255	Green (0-100%)
3	000-255	Blue (0-100%)
4	000-255	White (0-100%)
5	000-255	Amber (0-100%)
6	000-255	UV (0-100%)

### 8 channel mode:

Channel	Value	Function
1	000-255	Master dimmer (0-100%)
2	000-255	Red (0-100%)
3	000-255	Green (0-100%)
4	000-255	Blue (0-100%)
5	000-255	White (0-100%)
6	000-255	Amber (0-100%)
7	000-255	UV (0-100%)
8	000-255	Strobe (slow-fast)

### 10 channel mode:

Channel	Value	Function
1	000-255	Master dimmer (0-100%)
2	000-255	Red (0-100%)
3	000-255	Green (0-100%)
4	000-255	Blue (0-100%)
5	000-255	White (0-100%)
6	000-255	Amber (0-100%)
7	000-255	UV (0-100%)
8	000	No function
	001-020	Program 1
	021-041	Program 2
	042-062	Program 3
	063-083	Program 4
	084-104	Program 5
	105-125	Program 6
	126-146	Program 7
	147-167	Program 8
	168-188	Program 9
	189-209	Program 10
	210-230	Program 11
231-255	Program 12	
9	000	No function
	001-016	Red
	017-033	Green
	034-050	Blue
	051-067	White
	068-084	Amber
	085-101	UV
	102-118	Orange
	119-135	Yellow
	136-152	Magenta
	153-169	Hot Pink
	170-186	Cyan
	187-203	Pastel Red
	204-220	Pastel Green
	221-237	Pastel Blue
238-254	Warm White	
255	Cool White	
10	000-255	Strobe (slow-fast)

### Built-in program mode:

To access the built-in program mode press “**MODE**” until the display shows *Pr.01* on the LED display. Press “**SETUP**” to confirm the setting. Use the “**UP**” and “**DOWN**” buttons to select a program from *Pr.01 ~ Pr.12*. Press the “**SETUP**” button to confirm the setting.

To change the speed of the selected program press the “**SETUP**” button and then use the “**UP**” and “**DOWN**” buttons to select any value from *SP00 ~ SP99*. Press the “**SETUP**” button to confirm the setting, then use the “**UP**” and “**DOWN**” buttons to select and value from *F500 ~ F599* for the strobe feature. Press the “**SETUP**” button to confirm the setting.

In *Pr.01* you are able to set a specific static colour. When in *Pr.01* press the “**SETUP**” button and then use the “**UP**” and “**DOWN**” buttons to go through the static colours. Press the “**SETUP**” button to confirm the setting, then use the “**UP**” and “**DOWN**” buttons to select and value from *F500 ~ F599* for the strobe feature. Press the “**SETUP**” button to confirm the setting.

To exit out of any of the above options, press the “**MODE**” button.

### Programs:

Pr.01	Static colour
Pr.02	6 colour fade in/out
Pr.03	Colour fade in/out
Pr.04	Colour fade
Pr.05	6 colour change
Pr.06	Colour change
Pr.07	Red continuous fade
Pr.08	Green continuous fade
Pr.09	Blue continuous fade
Pr.10	White continuous fade
Pr.11	Amber continuous fade
Pr.12	UV continuous fade

### Static colours:

00FF - Blackout
1--r - Red
2--g - Green
3--b - Blue
4--w - White
5--A - Amber

6--l - UV
7--o - Orange
8--y - Yellow
9--m - Magenta
10--r - Hot Pink
11--c - Cyan

12--r - Pastel Red
13--g - Pastel Green
14--b - Pastel Blue
15--w - Warm White
16--c - Cool White

### Master/slave mode:

To set the master unit, press the “**MODE**” button on the rear of the master unit then select your desired program (sound active, auto, static colour or one of the built-in programs). To set the other units in slave mode, press the “**MODE**” button on the rear of the unit to show *SLAVE* on the LED display and press the “**SETUP**” button to confirm the setting. The units will now run in sequence with the master unit.

To exit out of any of the above options, press the “**MODE**” button.

Please ensure that all slave units are set to the same DMX channel mode as the master unit.

### Auto mode:

To access the auto mode press “**MODE**” until the display shows *AUTO* on the LED display. The fixture will now run through its built in programs *Pr.02 ~ Pr. 12*. To exit out of any of the above options, press the “**MODE**” button. NOTE: The user can set up the speed and flash speed for *Pr.02 ~ Pr. 12* under the built in programs mode. Changing this here will then take effect when running auto mode.

### RGBWAUV colour mix mode:

To access the static colour mode press “**MODE**” until *Color* shows on the LED display. Now press the “**SETUP**” button and use the “**UP**” and “**DOWN**” buttons to select the brightness between *r.000 ~ r.255*. Press the “**SETUP**” button and repeat for green (*G*), blue (*b*), white (*u*), amber (*A*) and UV (*l*).

**Value: 000 - 255 (000 = low brightness, 255 = high brightness)**

To exit out of any of the above options, press the “**MODE**” button.

### Factory reset:

To reset the fixture to factory settings, power the fixture off. Press and hold the “**MODE**” and “**SETUP**” buttons whilst powering the unit up. Keep hold of the “**MODE**” and “**SETUP**” buttons for 3 seconds after power up. The unit will now have reset to factory settings.

### Menu system

Built-in program	<i>Pr.01</i> Static colour <i>Pr.02</i> 6 colour fade in/out <i>Pr.03</i> Colour fade in/out <i>Pr.04</i> Colour fade <i>Pr.05</i> 6 colour change <i>Pr.06</i> Colour change <i>Pr.07</i> Red continuous fade <i>Pr.08</i> Green continuous fade <i>Pr.09</i> Blue continuous fade <i>Pr.10</i> White continuous fade <i>Pr.11</i> Amber continuous fade <i>Pr.12</i> UV continuous fade <i>SP00~SP99</i> (speed) <i>F500~F599</i> (flash)
RGBWAUV colour mix mode	<i>r.000~r.255</i> Red <i>g.000~g.255</i> Green <i>b.000~b.255</i> Blue <i>u.000~u.255</i> White <i>A.000~A.255</i> Amber <i>l.000~l.255</i> UV
Auto mode	<i>AUTO</i>
Slave mode	<i>SLAVE</i>
DMX mode	6CH, 8CH, 10CH
Address setting	<i>d.001~d.512</i>

### Setting the DMX address:

The DMX mode enables the use of a universal DMX controller. Each fixture requires a “start address” from 1- 512. A fixture requiring one or more channels for control begins to read the data on the channel indicated by the start address. For example, a fixture that occupies or uses 7 channels of DMX and was addressed to start on DMX channel 100, would read data from channels: 100,101,102,103,104,105 and 106. Choose a start address so that the channels used do not overlap. E.g. the next unit in the chain starts at 107.

### DMX 512:

DMX (Digital Multiplex) is a universal protocol used as a form of communication between intelligent fixtures and controllers. A DMX controller sends DMX data instructions from the controller to the fixture. DMX data is sent as serial data that travels from fixture to fixture via the DATA “IN” and DATA “OUT” XLR terminals located on all DMX fixtures (most controllers only have a data “out” terminal).











### DMX linking:

DMX is a language allowing all makes and models of different manufactures to be linked together and operate from a single controller, as long as all fixtures and the controller are DMX compliant. To ensure proper DMX data transmission, when using several DMX fixtures try to use the shortest cable path possible. The order in which fixtures are connected in a DMX line does not influence the DMX addressing. For example; a fixture assigned to a DMX address of 1 may be placed anywhere in a DMX line, at the beginning, at the end, or anywhere in the middle. When a fixture is assigned a DMX address of 1, the DMX controller knows to send DATA assigned to address 1 to that unit, no matter where it is located in the DMX chain.

**Also remember that DMX cable must be daisy chained and cannot be split.**

### DATA cable (DMX cable) requirements (for DMX operation):

This fixture can be controlled via DMX-512 protocol. The DMX address is set on the back of the unit. The last fixture in the signal/power chain should have a set of LEDJ93 termination plugs fitted to prevent water ingress into the connectors. Further DMX cables can be purchased from all good sound and lighting suppliers or Prolight Concepts dealers. Please quote:

LEDJ 1m Interior - Exterior DMX cable	LEDJ 1m Exterior DMX cable	LEDJ 2m Exterior DMX cable	LEDJ 5m Exterior DMX cable	LEDJ 10m Exterior DMX cable
				
Order code: LEDJ91	Order code: LEDJ141	Order code: LEDJ142	Order code: LEDJ143	Order code: LEDJ144
LEDJ 1m Exterior Power cable	LEDJ 2m Exterior Power cable	LEDJ 5m Exterior Power cable	LEDJ 10m Exterior Power cable	LEDJ Spectra Series End Cap Set
				
Order code: LEDJ146	Order code: LEDJ147	Order code: LEDJ148	Order code: LEDJ149	Order code: LEDJ93

**Notice:**

Be sure to follow the diagrams below when making your own cables. Do not connect the cables shield conductor to the ground lug or allow the shield conductor to come in contact with the XLRs outer casing. Grounding the shield could cause a short circuit and erratic behaviour.

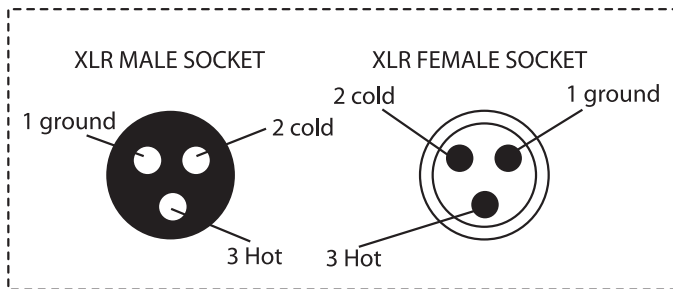
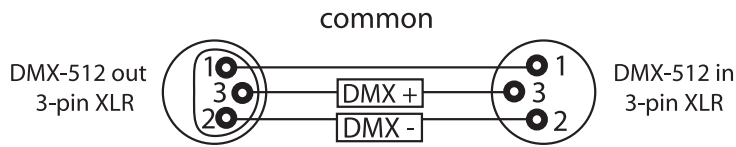

XLR Pin Configuration
Pin 1 = Ground
Pin 2 = Negative
Pin 3 = Postive

**Special note:**

**Line termination:**

When longer runs of cable are used, you may need to use a terminator on the last unit to avoid erratic behaviour.

**Using a cable terminator will decrease the possibilities of erratic behaviour.**

**(3-pin - Order ref: CABL90, 5-pin - Order ref: CABL89)**

Termination reduces signal transmission problems and interference. it is always advisable to connect a DMX terminal, (resistance 120 Ohm 1/4 W) between pin 2 (DMX-) and pin 3 (DMX+) of the last fixture.

**5-pin XLR DMX connectors:**

Some manufactures use 5-pin XLR connectors for data transmission in place of 3-pin. 5-pin XLR fixtures may be implemented in a 3-pin XLR DMX line. When inserting standard 5-pin XLR connectors in to a 3-pin line a cable adaptor must be used. The diagram below details the correct cable conversion.

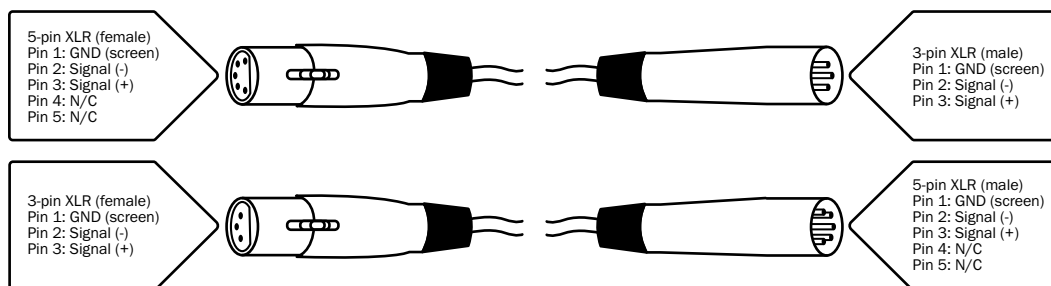





### ***Correct Disposal of this Product (Waste Electrical & Electronic Equipment)***

**(Applicable in the European Union and other European countries  
with separate collection systems)**

This marking shown on the product or its literature, indicates that it should not be disposed of with other household wastes at the end of its working life. To prevent possible harm to the environment or human health from uncontrolled waste disposal, please separate this from other types of wastes and recycle it responsibly to promote the sustainable reuse of material resources.

Household users should contact either the retailer where they purchased this product, or their local government office, for details of where and how they can take this item for environmentally safe recycling.

Business users should contact their supplier and check the terms and conditions of the purchase contract. This product should not be mixed with other commercial wastes for disposal.







**LEDj**